

Material: \_\_\_\_\_  
Granite Color

**REQUEST OF A LAYOUT  
ORDER BUDDY**

Check Lettering Style(s)

Tablet Size: _____ X _____ X _____ Length Width Height	Model #: _____ Shape & Finish
Base Size: _____ X _____ X _____ Length Width Height	Model #: _____ Shape & Finish
Vase Size: _____ X _____ X _____ Quantity Length Width Height 1 2	Style: _____ Vase Type

- FLARE BLOCK
- FROSTED INLAID
- POLISHED EDGE**
- SAND SUNK**
- Script Lettering*
- SHADOW**
- VERMARCO**

YOUR MAILING OR BUSINESS STAMP CAN GO HERE

AMC #: \_\_\_\_\_  
Send Layout to AMC#

Name: \_\_\_\_\_  
Contact Person

Material: \_\_\_\_\_  
Granite Color

**REQUEST OF A LAYOUT**  
**ORDER BUDDY GRASS MARKER SINGLE**

Check Lettering Style(s)

Tablet Size: _____ X _____ X _____ Length Width Height	Model #: _____ Shape & Finish
Base Size: _____ X _____ X _____ Length Width Height	Model #: _____ Shape & Finish
Vase Size: _____ X _____ X _____ Quantity Length Width Height 1 2	Style: _____ Vase Type

- FLARE BLOCK
- FROSTED INLAID
- POLISHED EDGE**
- SAND SUNK**
- Script Lettering*
- SHADOW**
- VERMARCO**

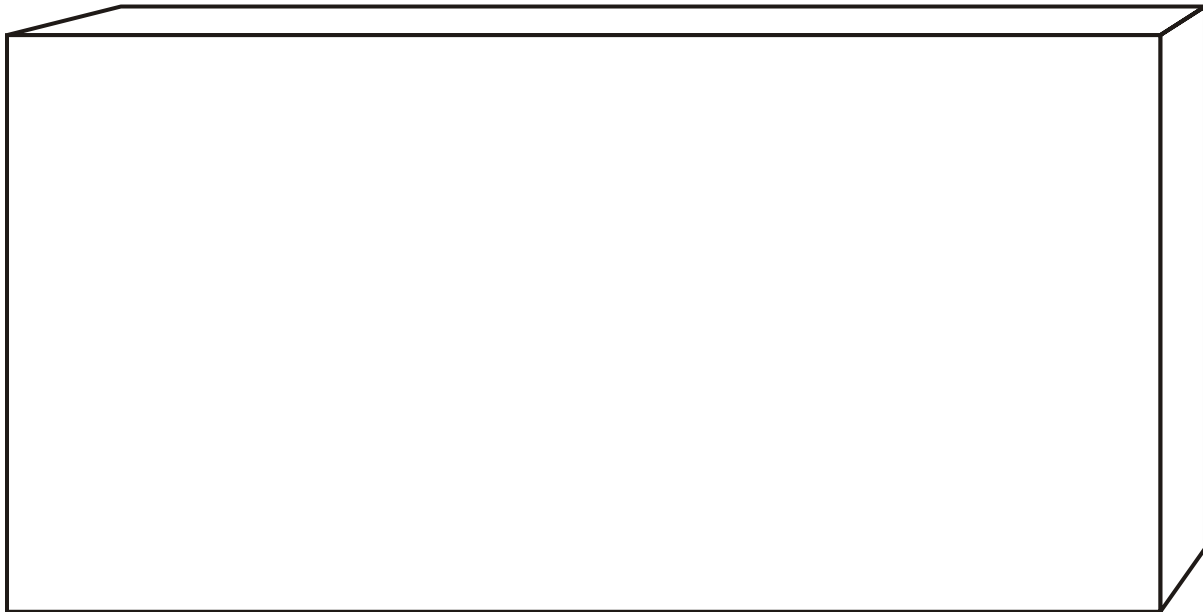

YOUR MAILING OR BUSINESS STAMP CAN GO HERE

AMC #: \_\_\_\_\_  
Send Layout to AMC#

Name: \_\_\_\_\_  
Contact Person

Material: \_\_\_\_\_  
Granite Color

**REQUEST OF A LAYOUT**  
**ORDER BUDDY GRASS MARKER DOUBLE**

Check Lettering Style(s)

Tablet Size: _____ X _____ X _____ Length Width Height	Model #: _____ Shape & Finish
Base Size: _____ X _____ X _____ Length Width Height	Model #: _____ Shape & Finish
Vase Size: _____ X _____ X _____ Quantity Length Width Height 1 2	Style: _____ Vase Type

- FLARE BLOCK
- FROSTED INLAID
- POLISHED EDGE**
- SAND SUNK**
- Script Lettering*
- SHADOW**
- VERMARCO**

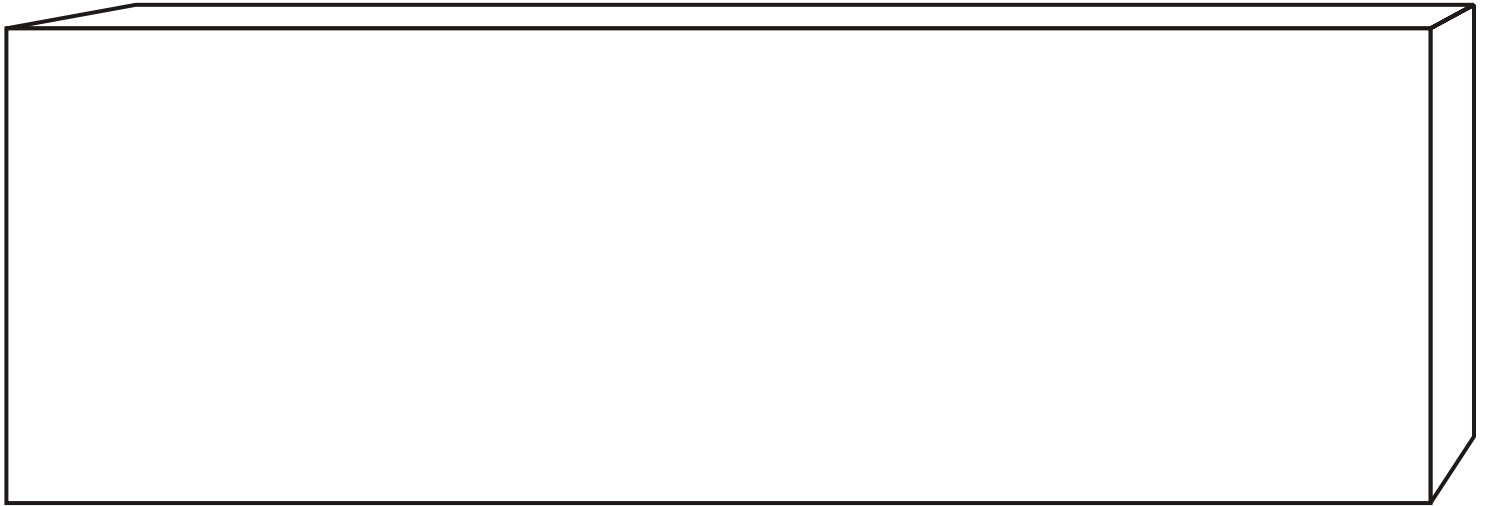

YOUR MAILING OR BUSINESS STAMP CAN GO HERE

AMC #: \_\_\_\_\_  
Send Layout to AMC#

Name: \_\_\_\_\_  
Contact Person

Material: \_\_\_\_\_  
Granite Color

**REQUEST OF A LAYOUT**  
**ORDER BUDDY PILLOW MARKER SINGLE**

Check Lettering Style(s)

Tablet Size: _____ X _____ X _____ Length Width Height	Model #: _____ Shape & Finish
Base Size: _____ X _____ X _____ Length Width Height	Model #: _____ Shape & Finish
Vase Size: _____ X _____ X _____ Quantity Length Width Height 1 2	Style: _____ Vase Type

- FLARE BLOCK
- FROSTED INLAID
- POLISHED EDGE**
- SAND SUNK**
- Script Lettering*
- SHADOW**
- VERMARCO**

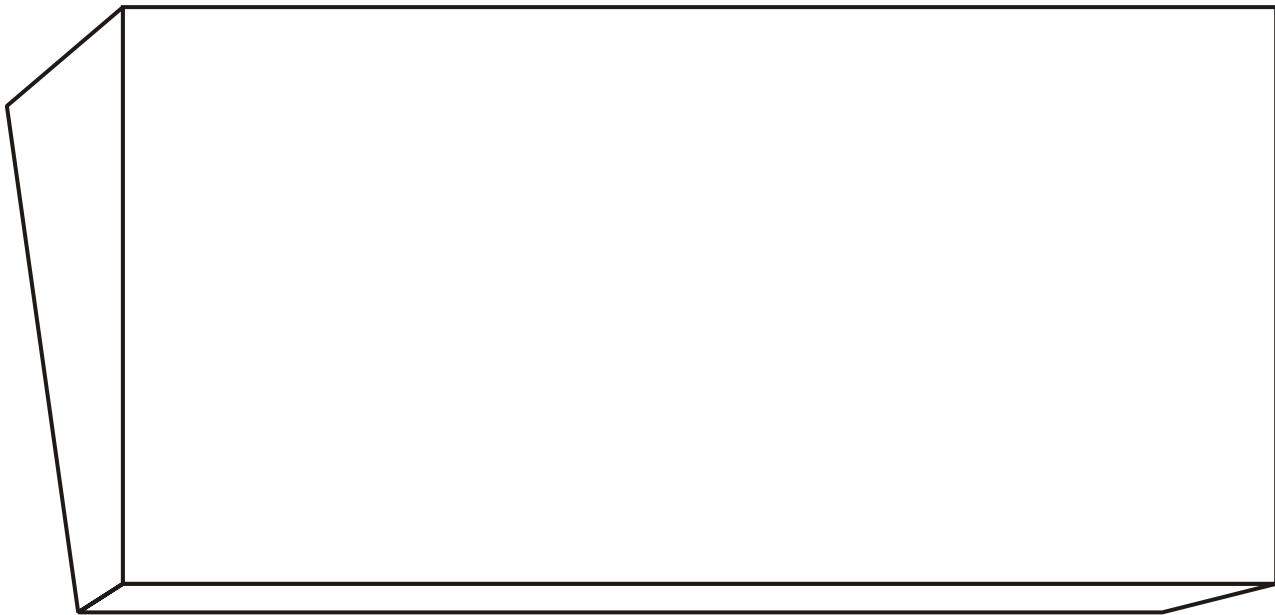

YOUR MAILING OR BUSINESS STAMP CAN GO HERE

AMC #: \_\_\_\_\_  
Send Layout to AMC#

Name: \_\_\_\_\_  
Contact Person

Material: \_\_\_\_\_  
Granite Color

**REQUEST OF A LAYOUT**  
**ORDER BUDDY PILLOW MARKER DOUBLE**

Check Lettering Style(s)

Tablet Size: _____ X _____ X _____ Length Width Height	Model #: _____ Shape & Finish
Base Size: _____ X _____ X _____ Length Width Height	Model #: _____ Shape & Finish
Vase Size: _____ X _____ X _____ Quantity Length Width Height 1 2	Style: _____ Vase Type

- FLARE BLOCK
- FROSTED INLAID
- POLISHED EDGE**
- SAND SUNK**
- Script Lettering*
- SHADOW**
- VERMARCO**

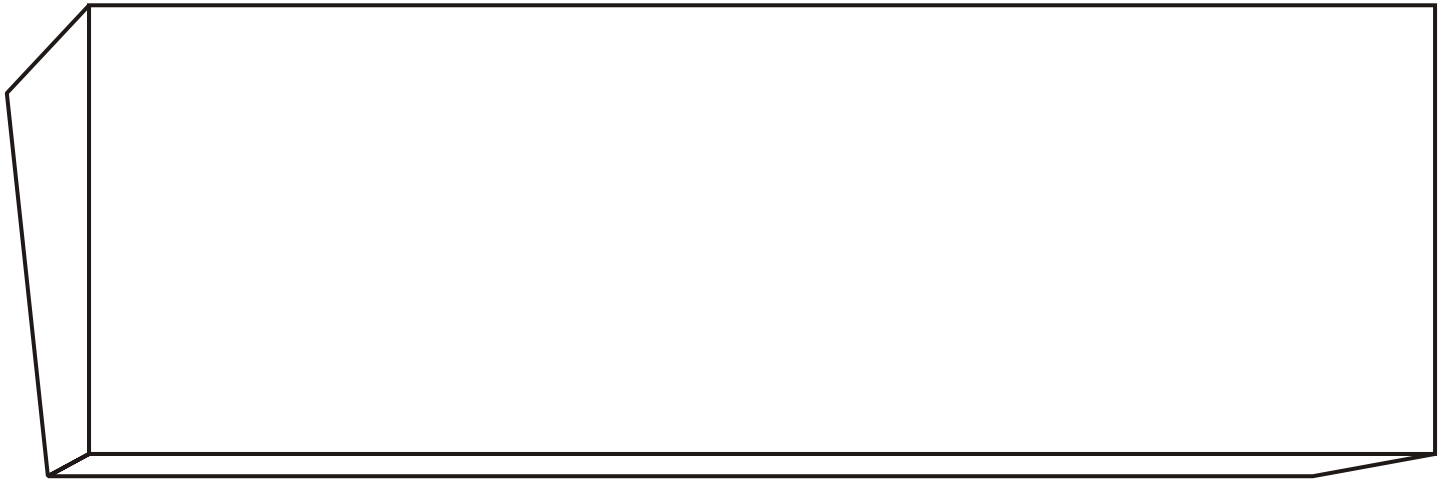

YOUR MAILING OR BUSINESS STAMP CAN GO HERE

AMC #: \_\_\_\_\_  
Send Layout to AMC#

Name: \_\_\_\_\_  
Contact Person

Material: \_\_\_\_\_  
Granite Color

**REQUEST OF A LAYOUT**  
**ORDER BUDDY SLANT STYLE SINGLE**

Check Lettering Style(s)

Tablet Size: _____ X _____ X _____ Length Width Height	Model #: _____ Shape & Finish
Base Size: _____ X _____ X _____ Length Width Height	Model #: _____ Shape & Finish
Vase Size: _____ X _____ X _____ Quantity Length Width Height 1 2	Style: _____ Vase Type

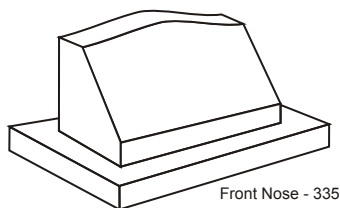

(Circle One)

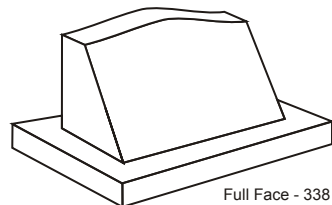

- FLARE BLOCK
- FROSTED INLAID
- POLISHED EDGE
- SAND SUNK
- Script Lettering
- SHADOW
- VERMARCO

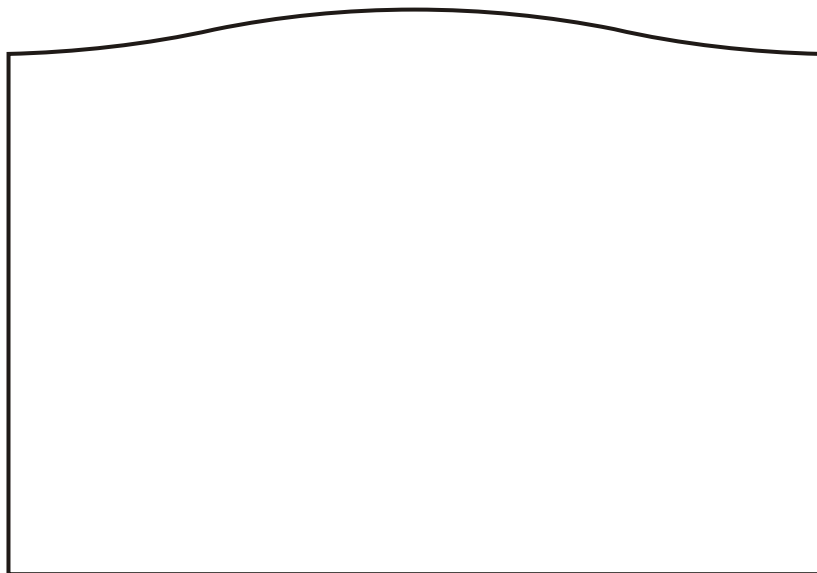

FRONT

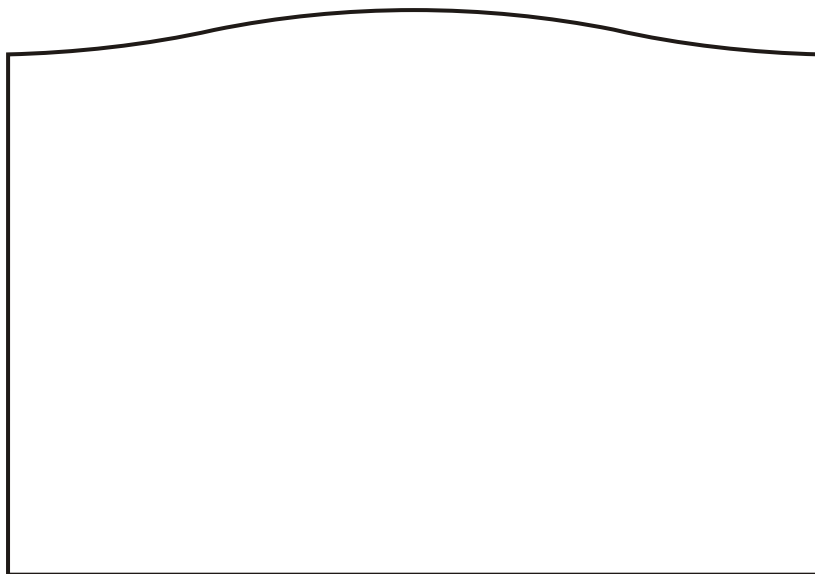

BACK

YOUR MAILING OR BUSINESS STAMP CAN GO HERE

AMC #: \_\_\_\_\_  
Send Layout to AMC#

Name: \_\_\_\_\_  
Contact Person

Material: \_\_\_\_\_  
Granite Color

**REQUEST OF A LAYOUT**  
**ORDER BUDDY SLANT STYLE DOUBLE**

Check Lettering Style(s)

Tablet Size: _____ X _____ X _____ Length Width Height	Model #: _____ Shape & Finish
Base Size: _____ X _____ X _____ Length Width Height	Model #: _____ Shape & Finish
Vase Size: _____ X _____ X _____ Quantity Length Width Height 1 2	Style: _____ Vase Type

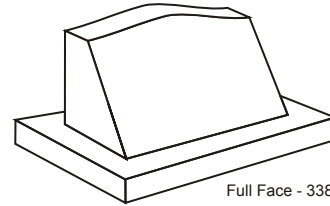
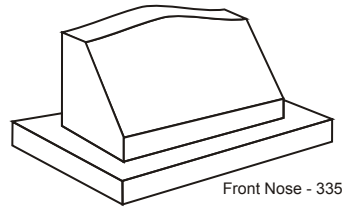

- FLARE BLOCK
- FROSTED INLAID
- POLISHED EDGE
- SAND SUNK
- Script Lettering
- SHADOW
- VERMARCO

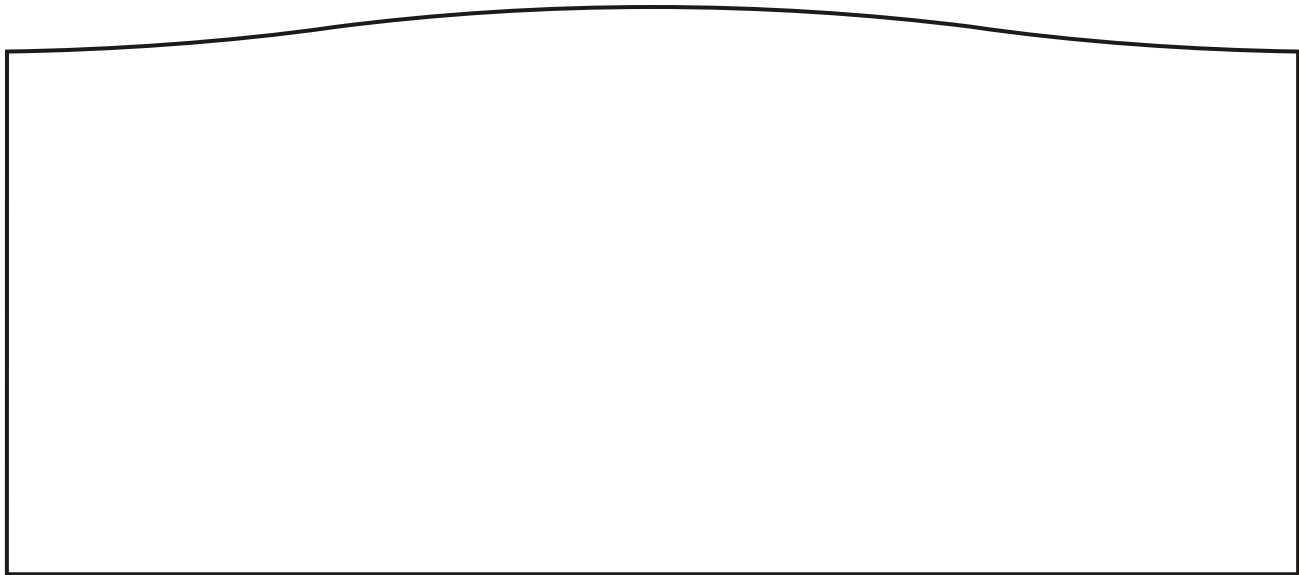

FRONT

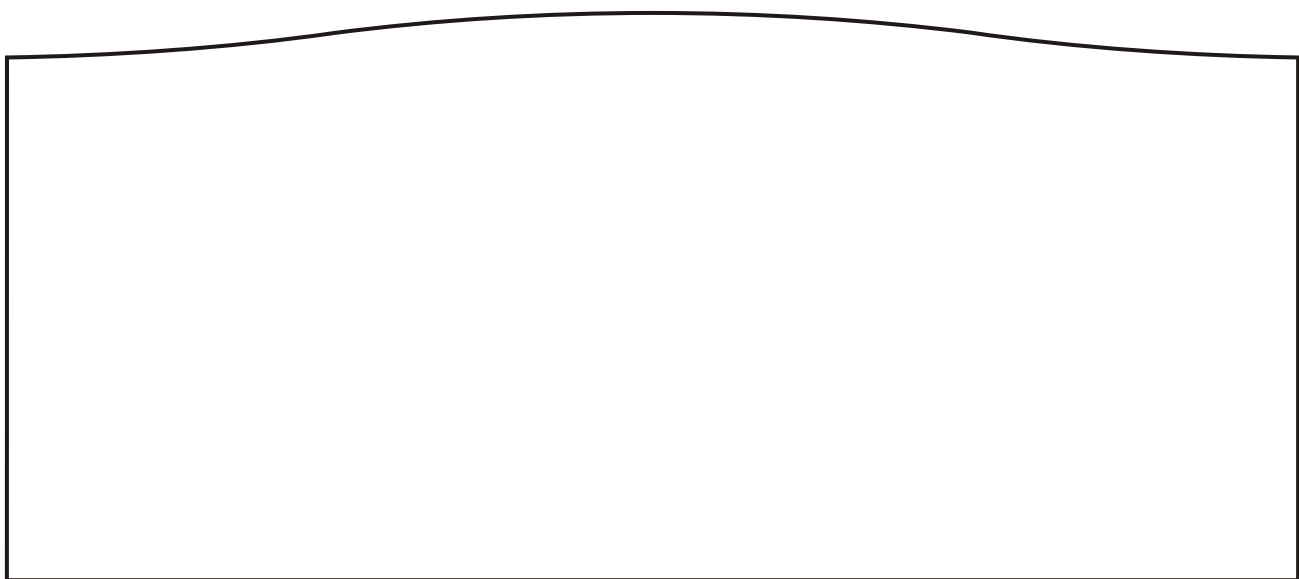

BACK

YOUR MAILING OR BUSINESS STAMP CAN GO HERE

AMC #: \_\_\_\_\_  
Send Layout to AMC#

Name: \_\_\_\_\_  
Contact Person

Material: \_\_\_\_\_  
Granite Color

**REQUEST OF A LAYOUT**  
**ORDER BUDDY SERP. TOP MONUMENT**

Check Lettering Style(s)

Tablet Size: _____ X _____ X _____ Length Width Height	Model #: _____ Shape & Finish
Base Size: _____ X _____ X _____ Length Width Height	Model #: _____ Shape & Finish
Vase Size: _____ X _____ X _____ Quantity Length Width Height 1 2	Style: _____ Vase Type

- FLARE BLOCK
- FROSTED INLAID
- POLISHED EDGE**
- SAND SUNK**
- Script Lettering*
- SHADOW**
- VERMARCO**

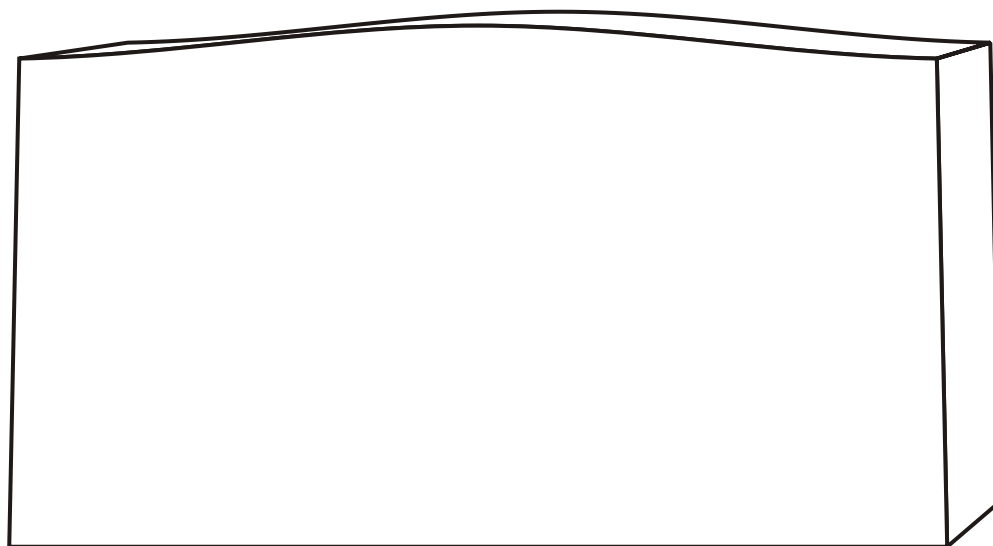
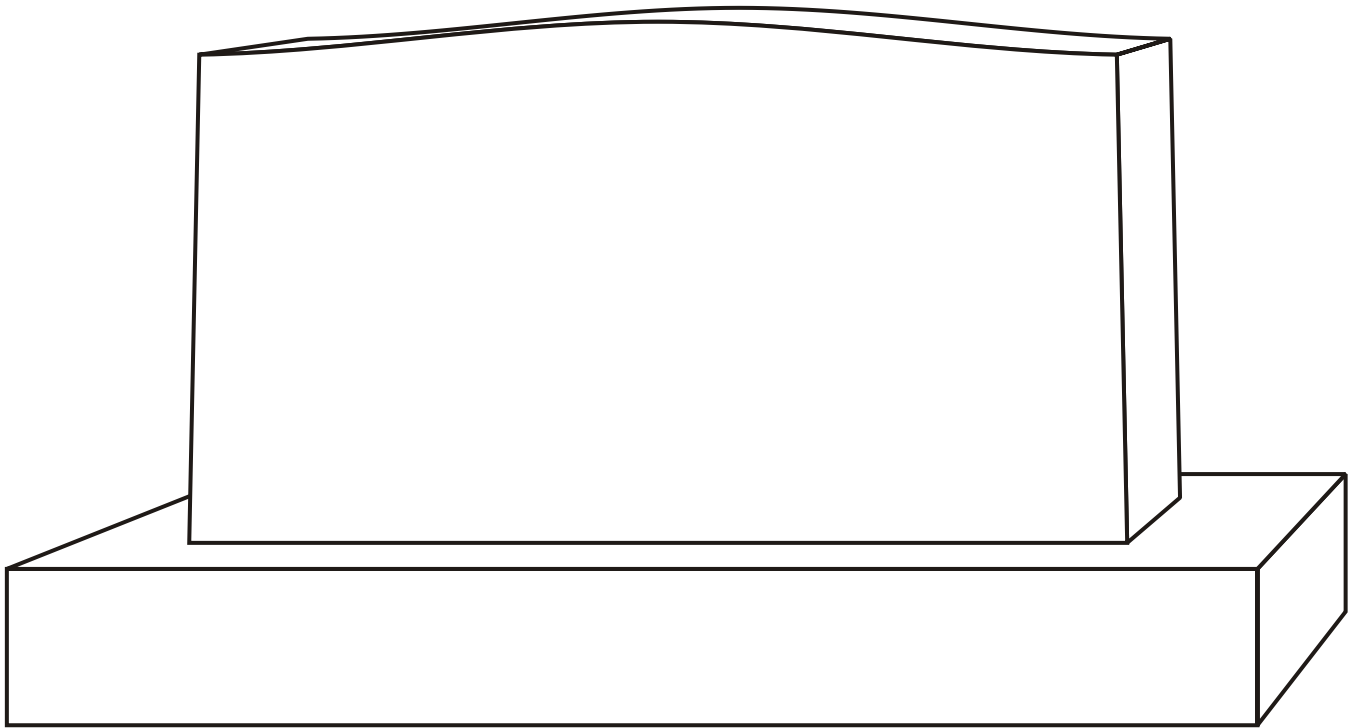

YOUR MAILING OR BUSINESS STAMP CAN GO HERE

AMC #: \_\_\_\_\_  
Send Layout to AMC#

Name: \_\_\_\_\_  
Contact Person

Material: \_\_\_\_\_  
Granite Color

**REQUEST OF A LAYOUT  
ORDER BUDDY CALHOUN SHAPE**

Check Lettering Style(s)

- FLARE BLOCK
- FROSTED INLAID
- POLISHED EDGE**
- SAND SUNK**
- Script Lettering*
- SHADOW**
- VERMARCO**

Tablet Size: _____ X _____ X _____ Length Width Height	Model #: _____ Shape & Finish
Base Size: _____ X _____ X _____ Length Width Height	Model #: _____ Shape & Finish
Vase Size: _____ X _____ X _____ Quantity Length Width Height 1 2	Style: _____ Vase Type

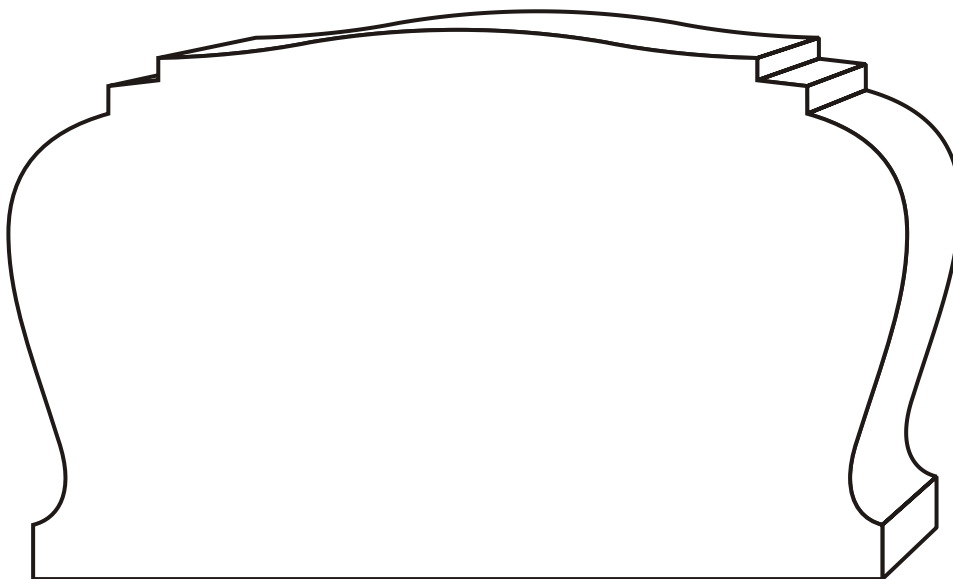
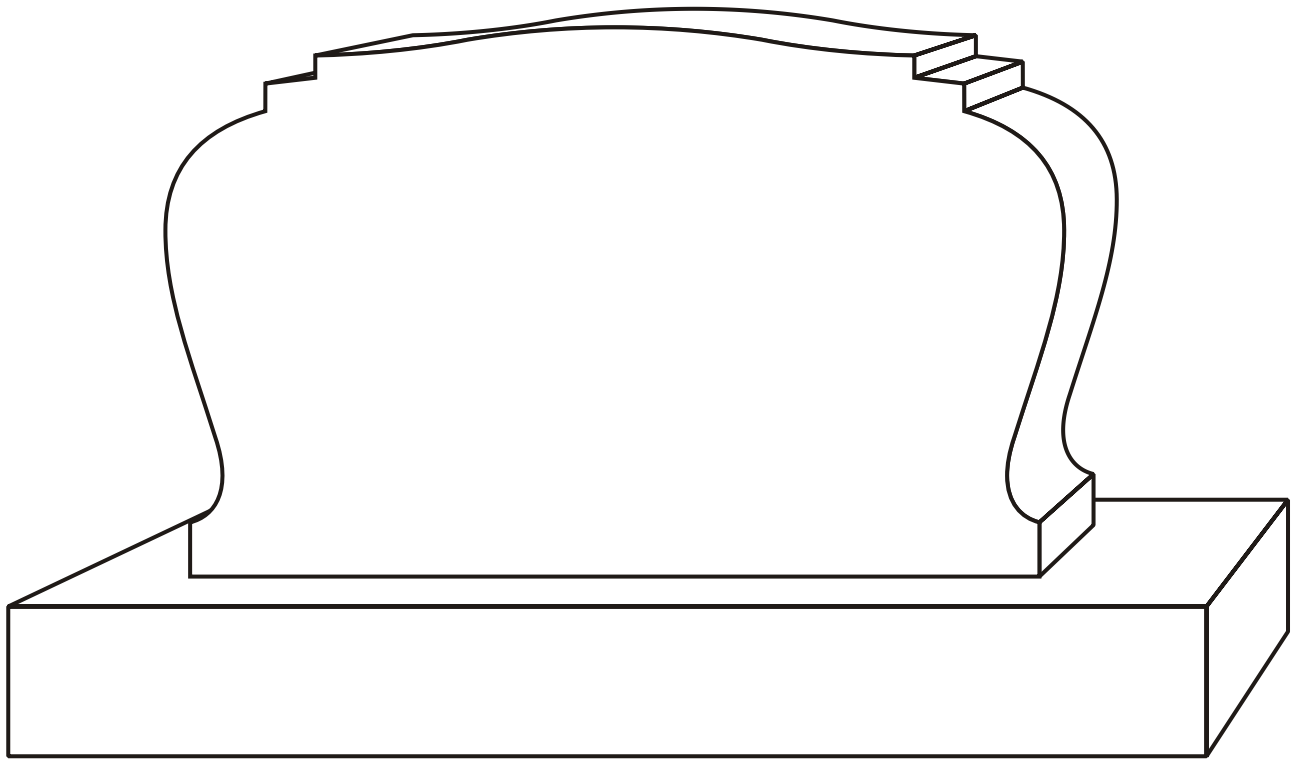

YOUR MAILING OR BUSINESS STAMP CAN GO HERE

AMC #: \_\_\_\_\_  
Send Layout to AMC#

Name: \_\_\_\_\_  
Contact Person

Material: \_\_\_\_\_  
Granite Color

**REQUEST OF A LAYOUT  
ORDER BUDDY STYLE L1001**

Check Lettering Style(s)

Tablet Size: _____ X _____ X _____ Length Width Height	Model #: _____ Shape & Finish
Base Size: _____ X _____ X _____ Length Width Height	Model #: _____ Shape & Finish
Vase Size: _____ X _____ X _____ Quantity Length Width Height 1 2	Style: _____ Vase Type

- FLARE BLOCK
- FROSTED INLAID
- POLISHED EDGE**
- SAND SUNK**
- Script Lettering*
- SHADOW**
- VERMARCO**

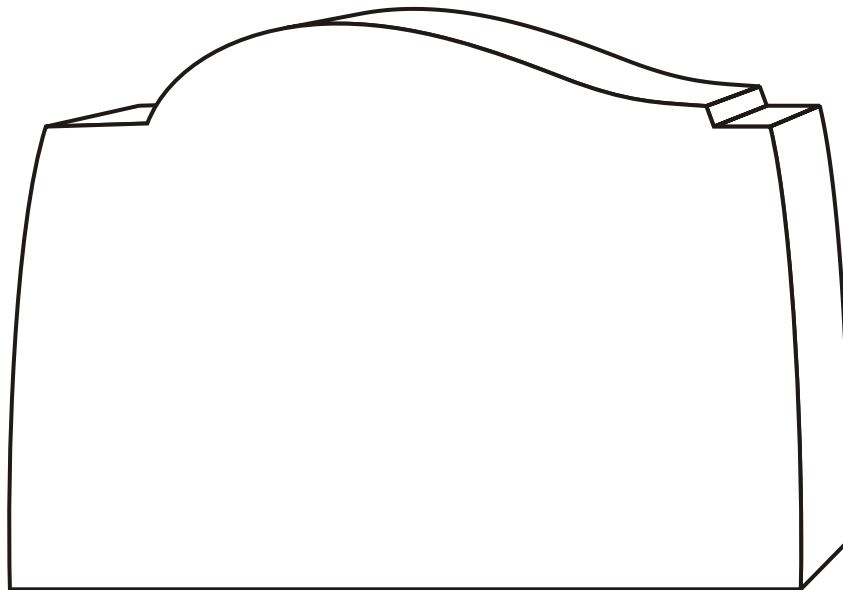
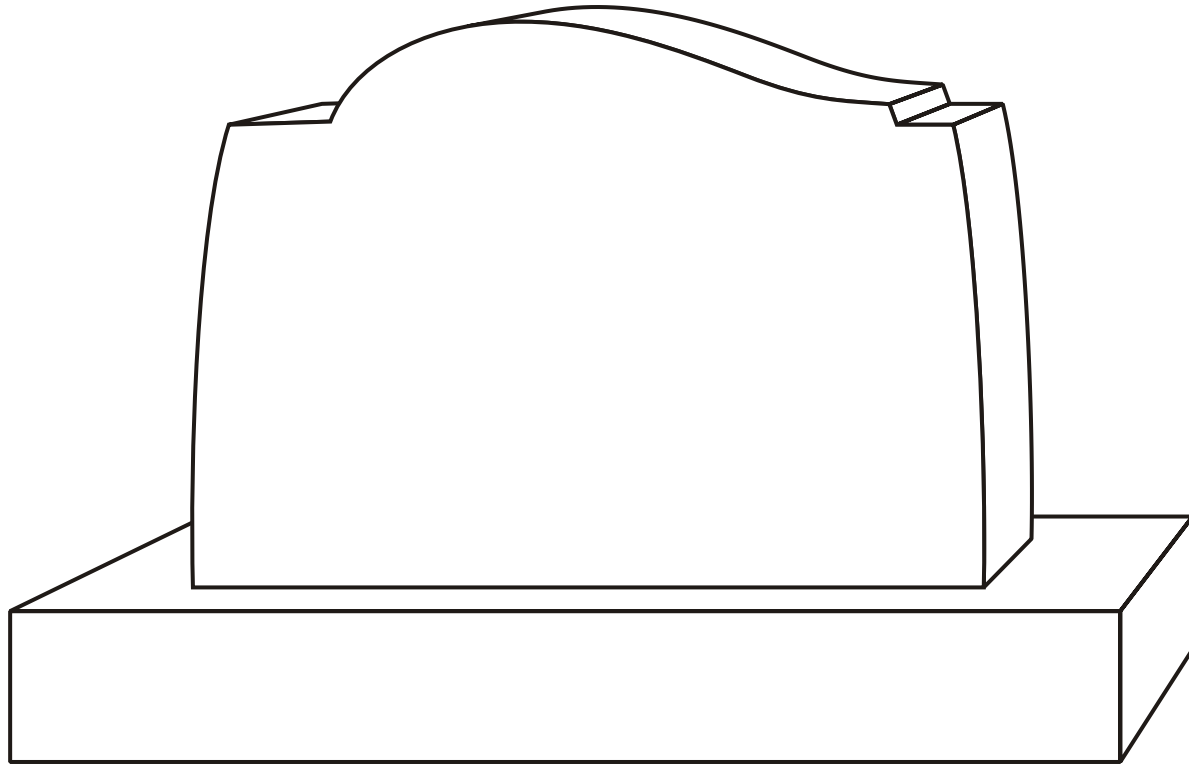

YOUR MAILING OR BUSINESS STAMP CAN GO HERE

AMC #: \_\_\_\_\_  
Send Layout to AMC#

Name: \_\_\_\_\_  
Contact Person

Material: \_\_\_\_\_  
Granite Color

**REQUEST OF A LAYOUT  
ORDER BUDDY STYLE L1002**

Check Lettering Style(s)

Tablet Size: _____ X _____ X _____ Length Width Height	Model #: _____ Shape & Finish
Base Size: _____ X _____ X _____ Length Width Height	Model #: _____ Shape & Finish
Vase Size: _____ X _____ X _____ Quantity Length Width Height 1 2	Style: _____ Vase Type

- FLARE BLOCK
- FROSTED INLAID
- POLISHED EDGE**
- SAND SUNK**
- Script Lettering*
- SHADOW**
- VERMARCO**

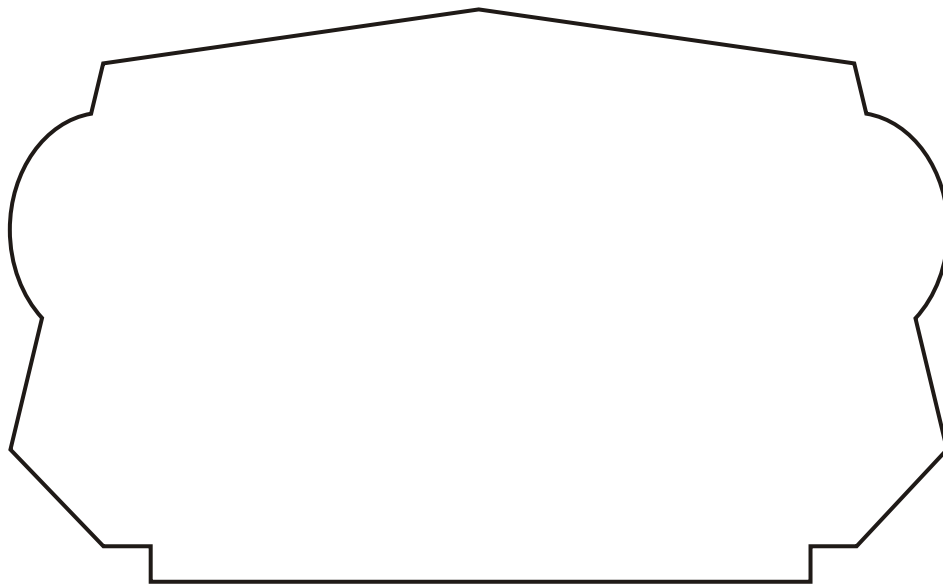
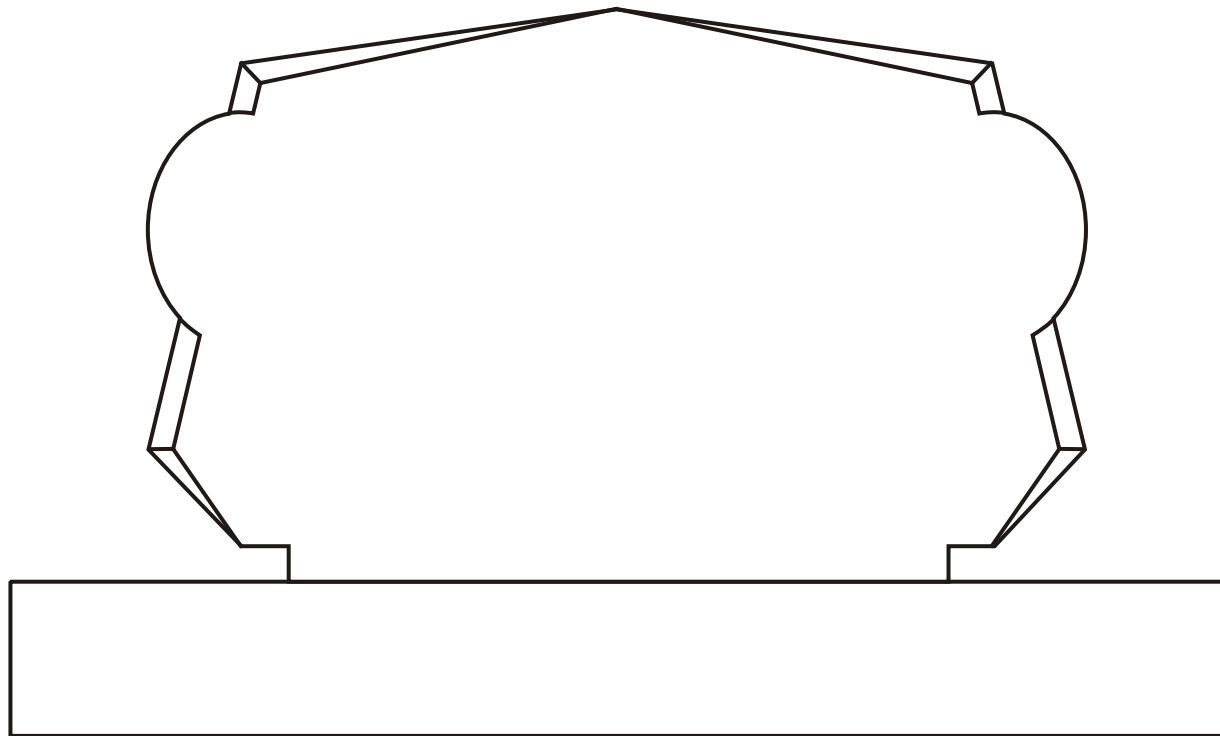

YOUR MAILING OR BUSINESS STAMP CAN GO HERE

AMC #: \_\_\_\_\_  
Send Layout to AMC#

Name: \_\_\_\_\_  
Contact Person

Material: \_\_\_\_\_  
Granite Color

**REQUEST OF A LAYOUT  
ORDER BUDDY RM7610**

Check Lettering Style(s)

Tablet Size: _____ X _____ X _____ Length Width Height	Model #: _____ Shape & Finish
Base Size: _____ X _____ X _____ Length Width Height	Model #: _____ Shape & Finish
Vase Size: _____ X _____ X _____ Quantity Length Width Height 1 2	Style: _____ Vase Type

- FLARE BLOCK
- FROSTED INLAID
- POLISHED EDGE**
- SAND SUNK**
- Script Lettering*
- SHADOW**
- VERMARCO**

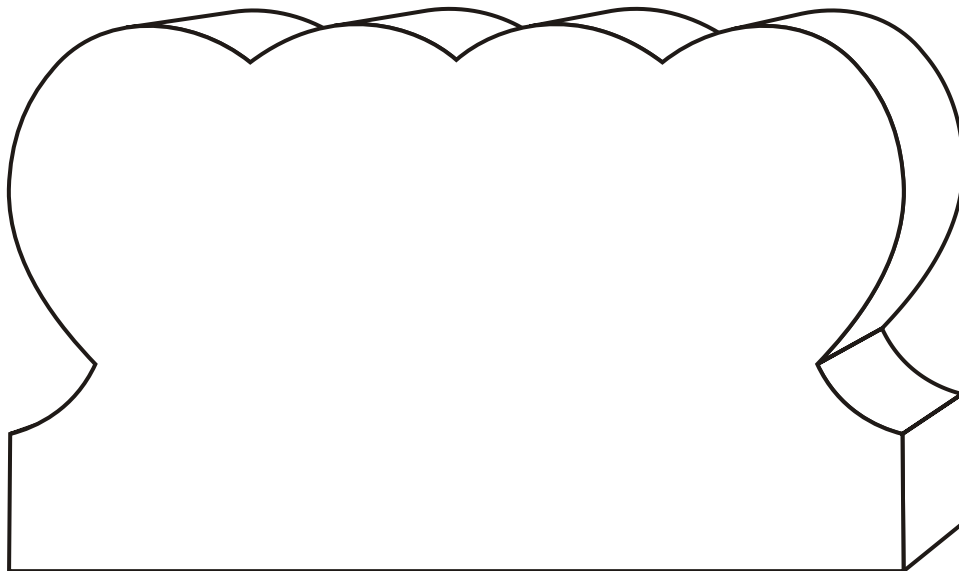
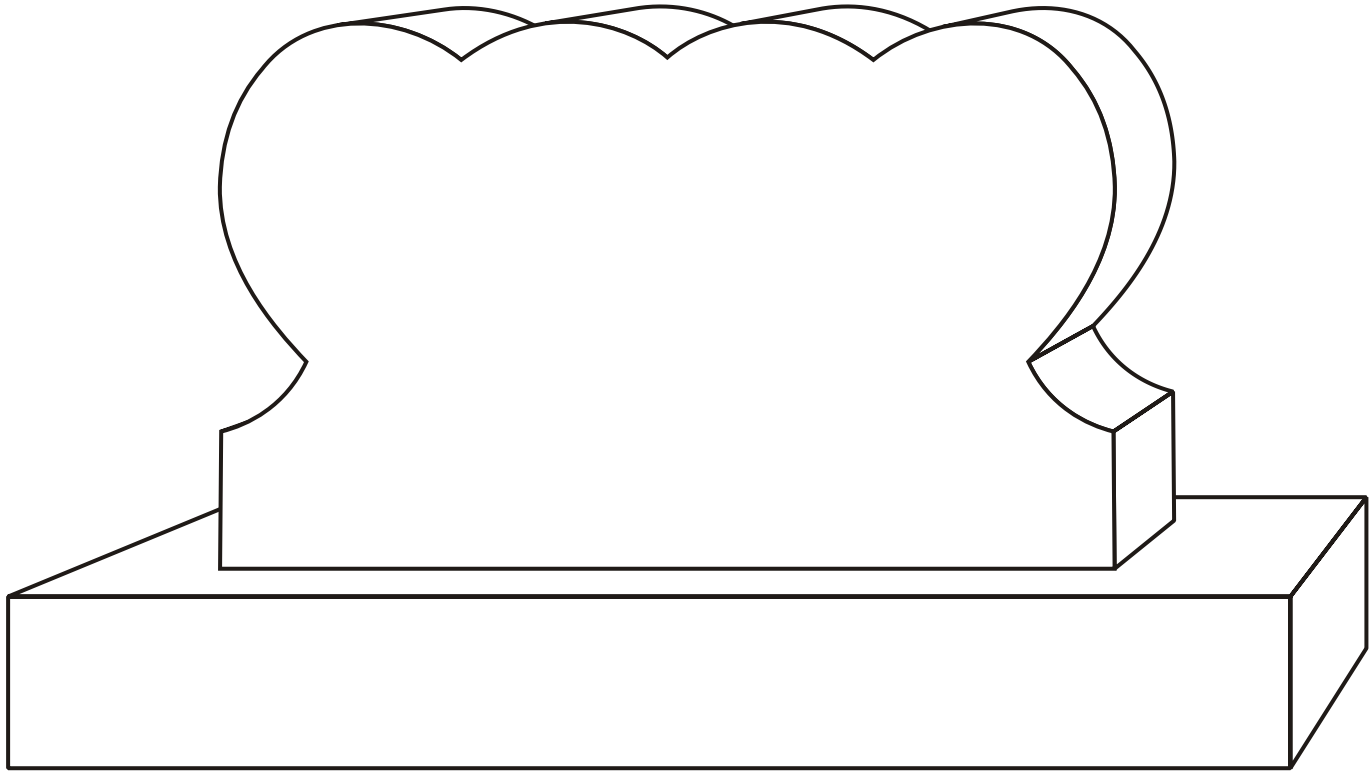

YOUR MAILING OR BUSINESS STAMP CAN GO HERE

AMC #: \_\_\_\_\_  
Send Layout to AMC#

Name: \_\_\_\_\_  
Contact Person

Material: \_\_\_\_\_  
Granite Color

**REQUEST OF A LAYOUT  
ORDER BUDDY STYLE T195M**

Check Lettering Style(s)

Tablet Size: _____ X _____ X _____ Length Width Height	Model #: _____ Shape & Finish
Base Size: _____ X _____ X _____ Length Width Height	Model #: _____ Shape & Finish
Vase Size: _____ X _____ X _____ Quantity Length Width Height 1 2	Style: _____ Vase Type

- FLARE BLOCK
- FROSTED INLAID
- POLISHED EDGE**
- SAND SUNK**
- Script Lettering*
- SHADOW**
- VERMARCO**

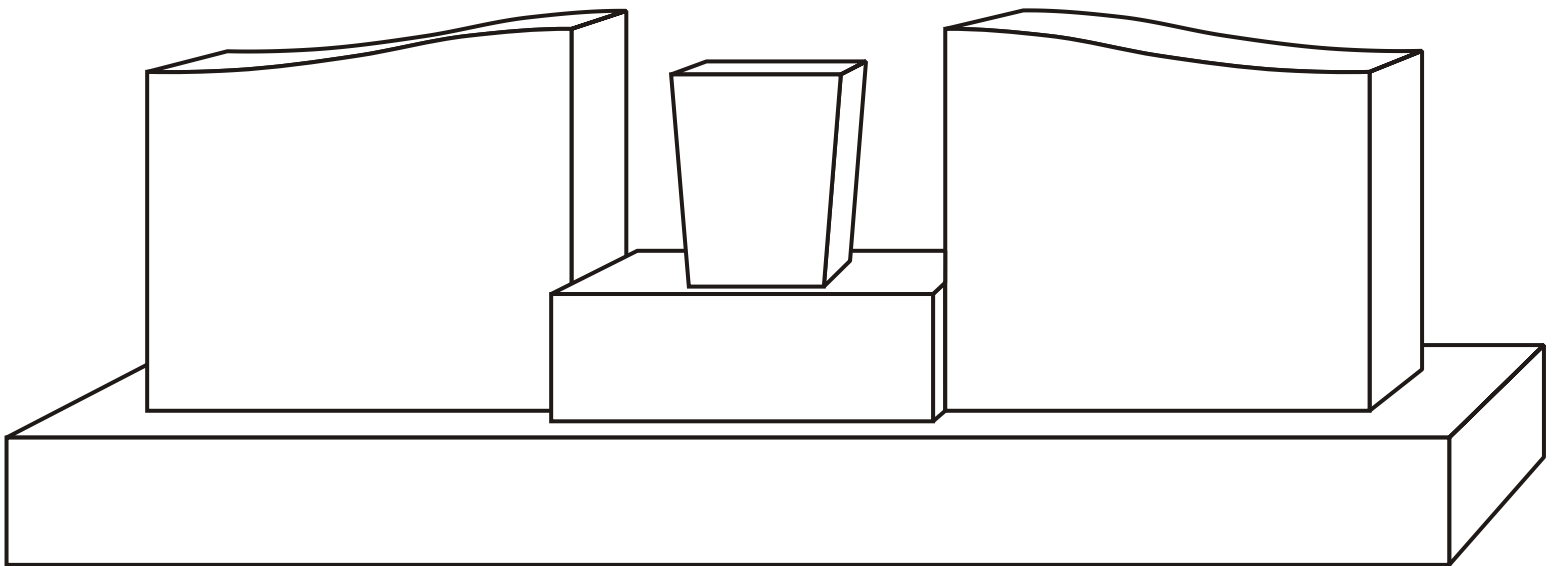
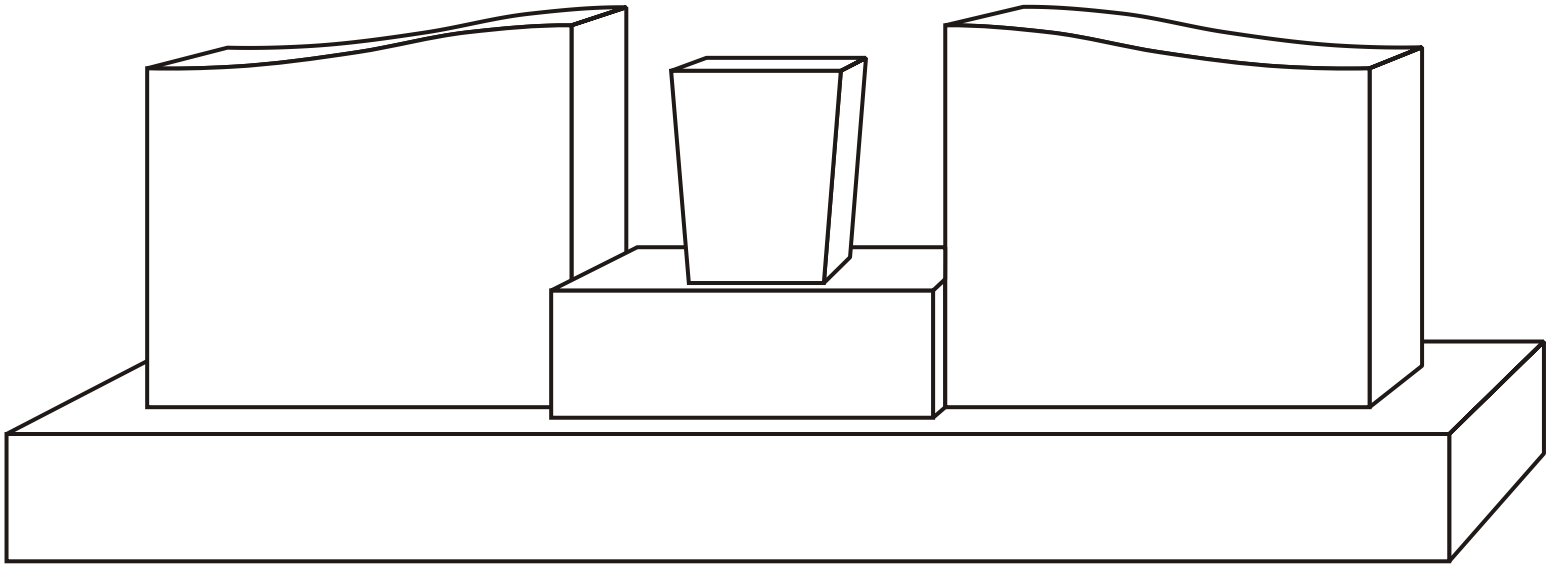

YOUR MAILING OR BUSINESS STAMP CAN GO HERE

AMC #: \_\_\_\_\_  
Send Layout to AMC#

Name: \_\_\_\_\_  
Contact Person

Material: \_\_\_\_\_  
Granite Color

**REQUEST OF A LAYOUT  
ORDER BUDDY STYLE 66-11**

Check Lettering Style(s)

Tablet Size: _____ X _____ X _____ Length Width Height	Model #: _____ Shape & Finish
Base Size: _____ X _____ X _____ Length Width Height	Model #: _____ Shape & Finish
Vase Size: _____ X _____ X _____ Quantity Length Width Height 1 2	Style: _____ Vase Type

- FLARE BLOCK
- FROSTED INLAID
- POLISHED EDGE**
- SAND SUNK**
- Script Lettering*
- SHADOW**
- VERMARCO**

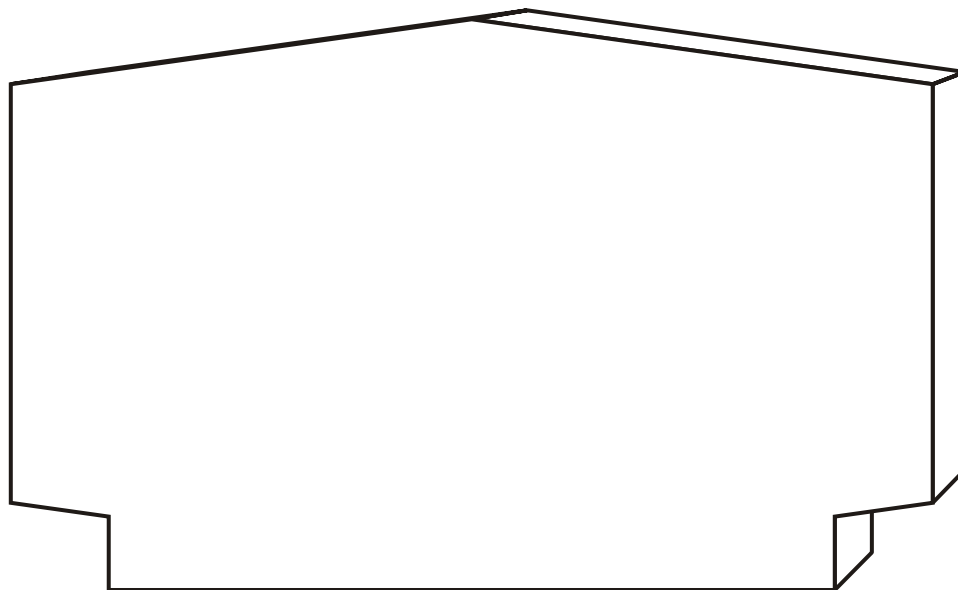
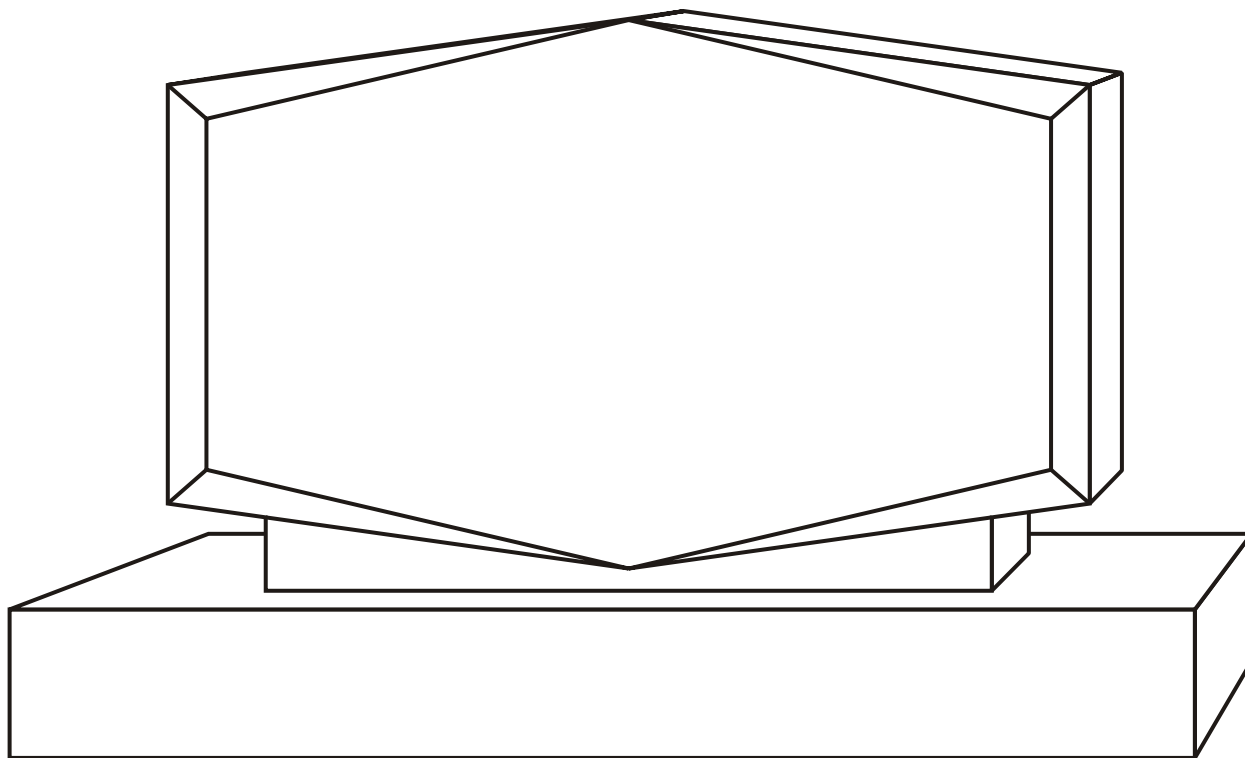

YOUR MAILING OR BUSINESS STAMP CAN GO HERE

AMC #: \_\_\_\_\_  
Send Layout to AMC#

Name: \_\_\_\_\_  
Contact Person

Material: \_\_\_\_\_  
Granite Color

**REQUEST OF A LAYOUT  
ORDER BUDDY STYLE 6616**

Check Lettering Style(s)

Tablet Size: _____ X _____ X _____ Length Width Height	Model #: _____ Shape & Finish
Base Size: _____ X _____ X _____ Length Width Height	Model #: _____ Shape & Finish
Vase Size: _____ X _____ X _____ Quantity Length Width Height 1 2	Style: _____ Vase Type

- FLARE BLOCK
- FROSTED INLAID
- POLISHED EDGE**
- SAND SUNK**
- Script Lettering*
- SHADOW**
- VERMARCO**

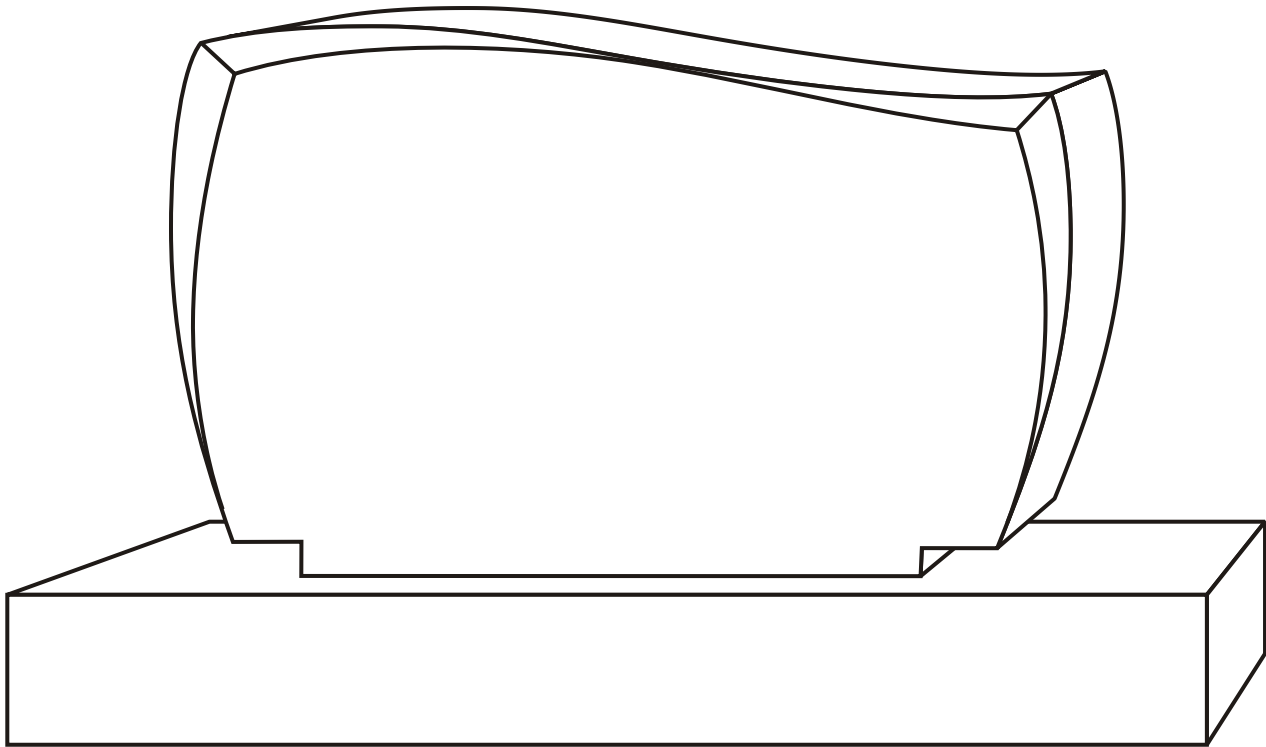

YOUR MAILING OR BUSINESS STAMP CAN GO HERE

AMC #: \_\_\_\_\_  
Send Layout to AMC#

Name: \_\_\_\_\_  
Contact Person

Material: \_\_\_\_\_  
Granite Color

**REQUEST OF A LAYOUT  
ORDER BUDDY STYLE L1065**

Check Lettering Style(s)

Tablet Size: _____ X _____ X _____ Length Width Height	Model #: _____ Shape & Finish
Base Size: _____ X _____ X _____ Length Width Height	Model #: _____ Shape & Finish
Vase Size: _____ X _____ X _____ Quantity Length Width Height 1 2	Style: _____ Vase Type

- FLARE BLOCK
- FROSTED INLAID
- POLISHED EDGE**
- SAND SUNK**
- Script Lettering*
- SHADOW**
- VERMARCO**

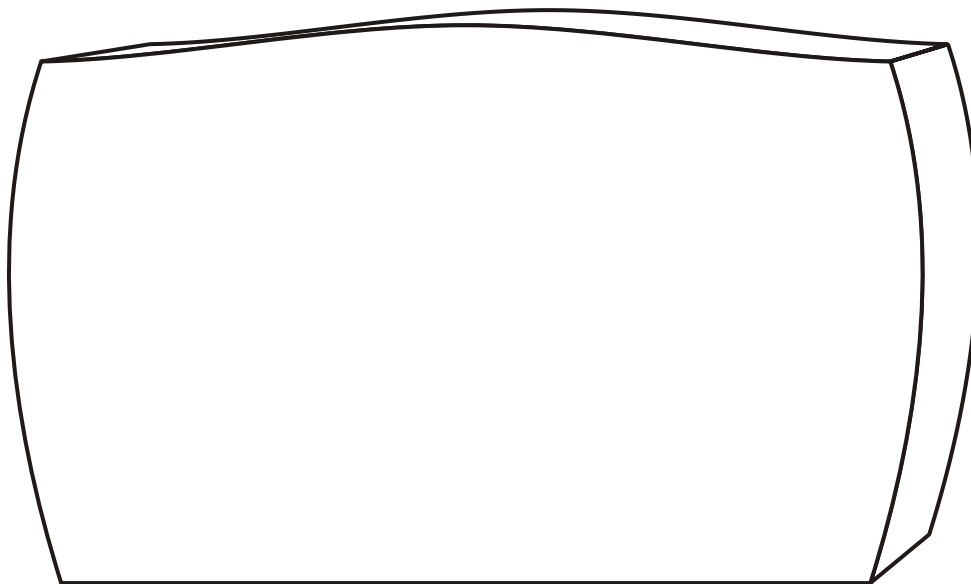
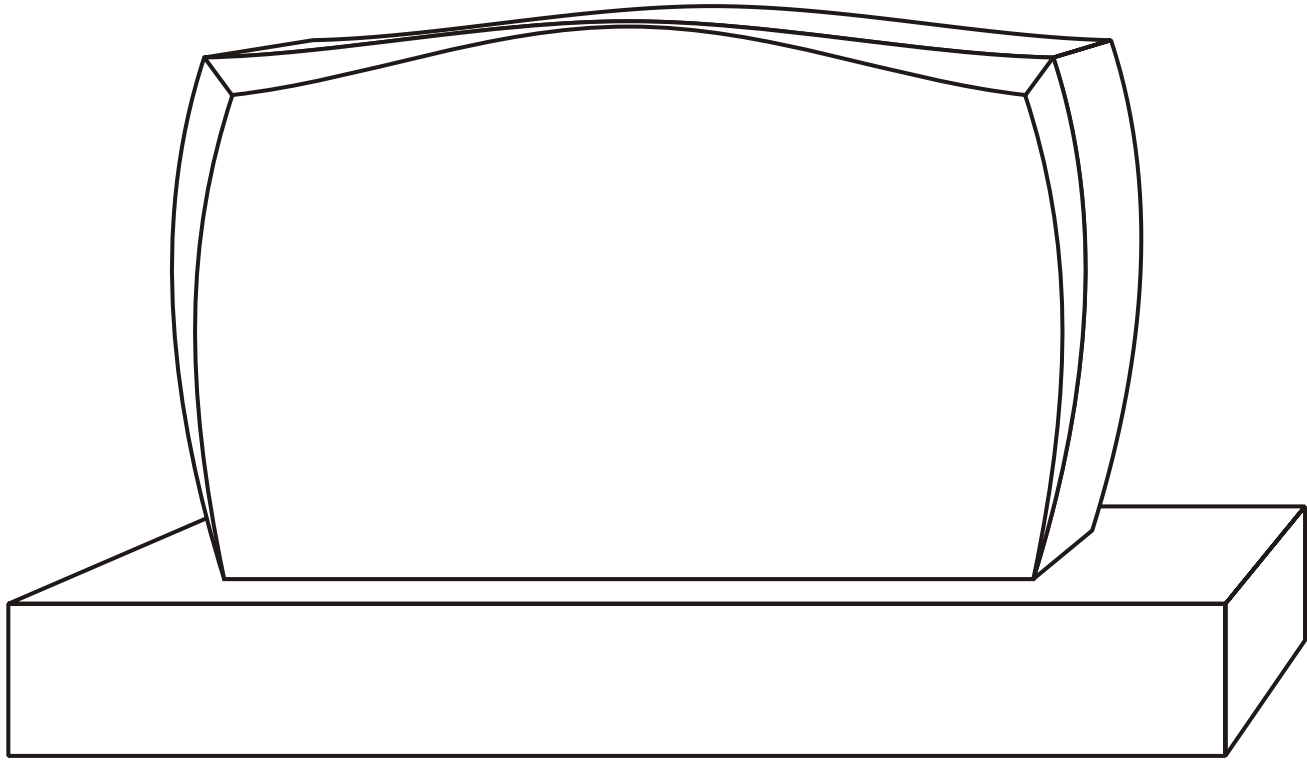

YOUR MAILING OR BUSINESS STAMP CAN GO HERE

AMC #: \_\_\_\_\_  
Send Layout to AMC#

Name: \_\_\_\_\_  
Contact Person

Material: \_\_\_\_\_  
Granite Color

**REQUEST OF A LAYOUT**  
**ORDER BUDDY STYLE RM9915**

Check Lettering Style(s)

Tablet Size: _____ X _____ X _____ Length Width Height	Model #: _____ Shape & Finish
Base Size: _____ X _____ X _____ Length Width Height	Model #: _____ Shape & Finish
Vase Size: _____ X _____ X _____ Quantity Length Width Height 1 2	Style: _____ Vase Type

- FLARE BLOCK
- FROSTED INLAID
- POLISHED EDGE**
- SAND SUNK**
- Script Lettering*
- SHADOW**
- VERMARCO**

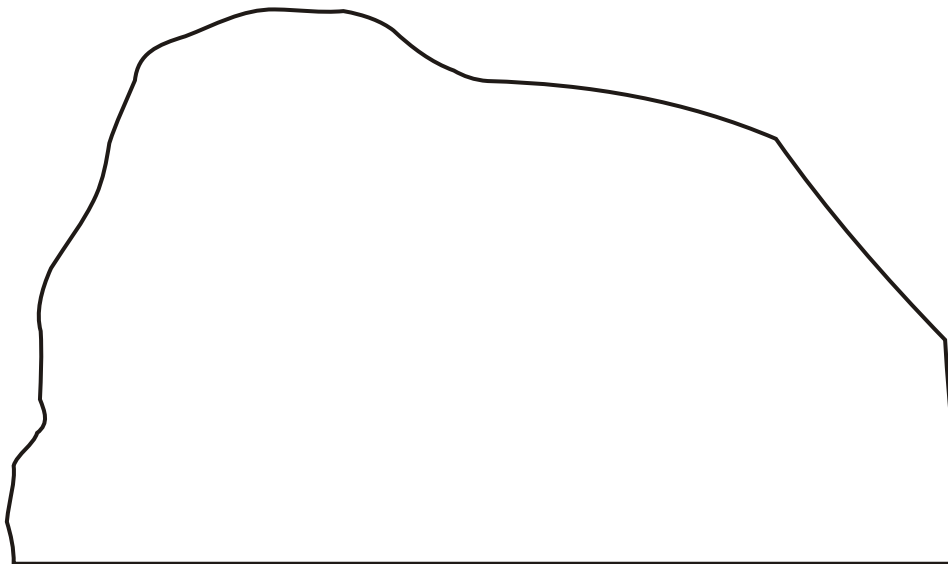
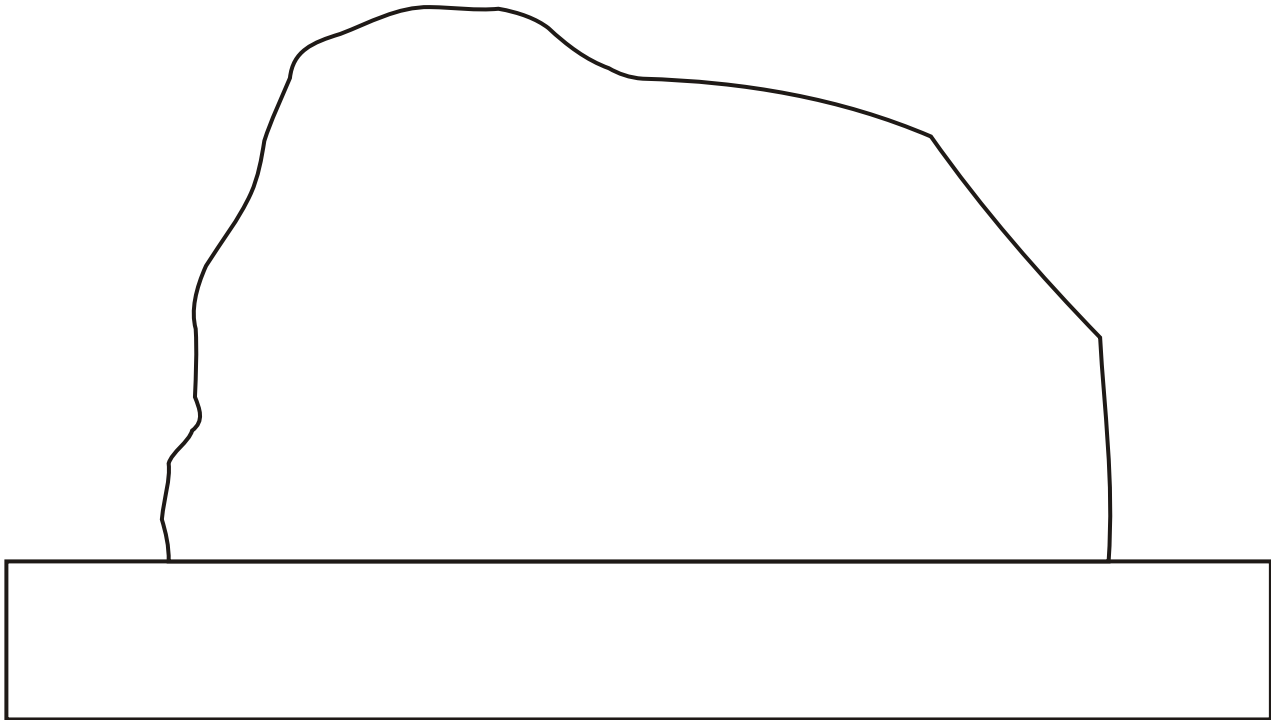

YOUR MAILING OR BUSINESS STAMP CAN GO HERE

AMC #: \_\_\_\_\_  
Send Layout to AMC#

Name: \_\_\_\_\_  
Contact Person

Material: \_\_\_\_\_  
Granite Color

**REQUEST OF A LAYOUT  
ORDER BUDDY STYLE L1080**

Check Lettering Style(s)

Tablet Size: _____ X _____ X _____ Length Width Height	Model #: _____ Shape & Finish
Base Size: _____ X _____ X _____ Length Width Height	Model #: _____ Shape & Finish
Vase Size: _____ X _____ X _____ Quantity Length Width Height 1 2	Style: _____ Vase Type

- FLARE BLOCK
- FROSTED INLAID
- POLISHED EDGE**
- SAND SUNK**
- Script Lettering*
- SHADOW**
- VERMARCO**

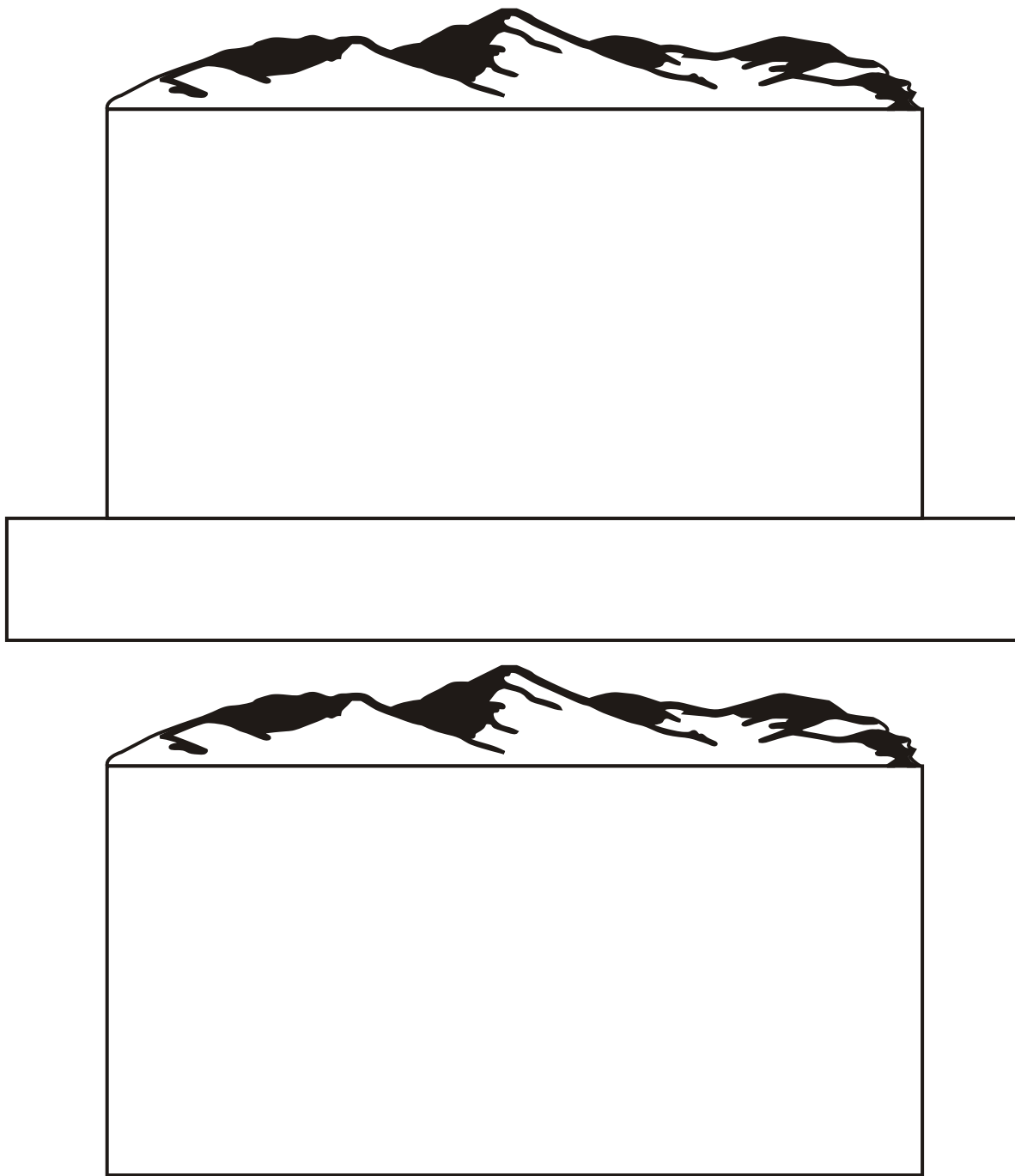

YOUR MAILING OR BUSINESS STAMP CAN GO HERE

AMC #: \_\_\_\_\_  
Send Layout to AMC#

Name: \_\_\_\_\_  
Contact Person

Material: \_\_\_\_\_  
Granite Color

**REQUEST OF A LAYOUT  
ORDER BUDDY STYLE L2050**

Check Lettering Style(s)

Tablet Size: _____ X _____ X _____ Length Width Height	Model #: _____ Shape & Finish
Base Size: _____ X _____ X _____ Length Width Height	Model #: _____ Shape & Finish
Vase Size: _____ X _____ X _____ Quantity Length Width Height 1 2	Style: _____ Vase Type

- FLARE BLOCK
- FROSTED INLAID
- POLISHED EDGE**
- SAND SUNK**
- Script Lettering*
- SHADOW**
- VERMARCO**

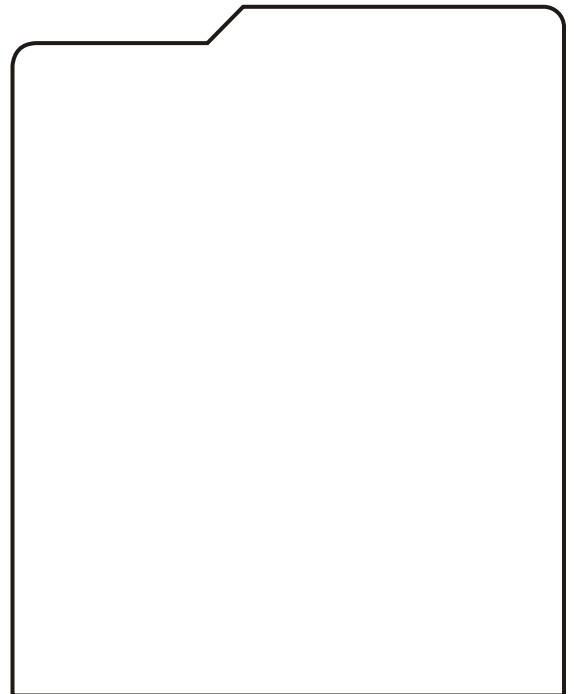
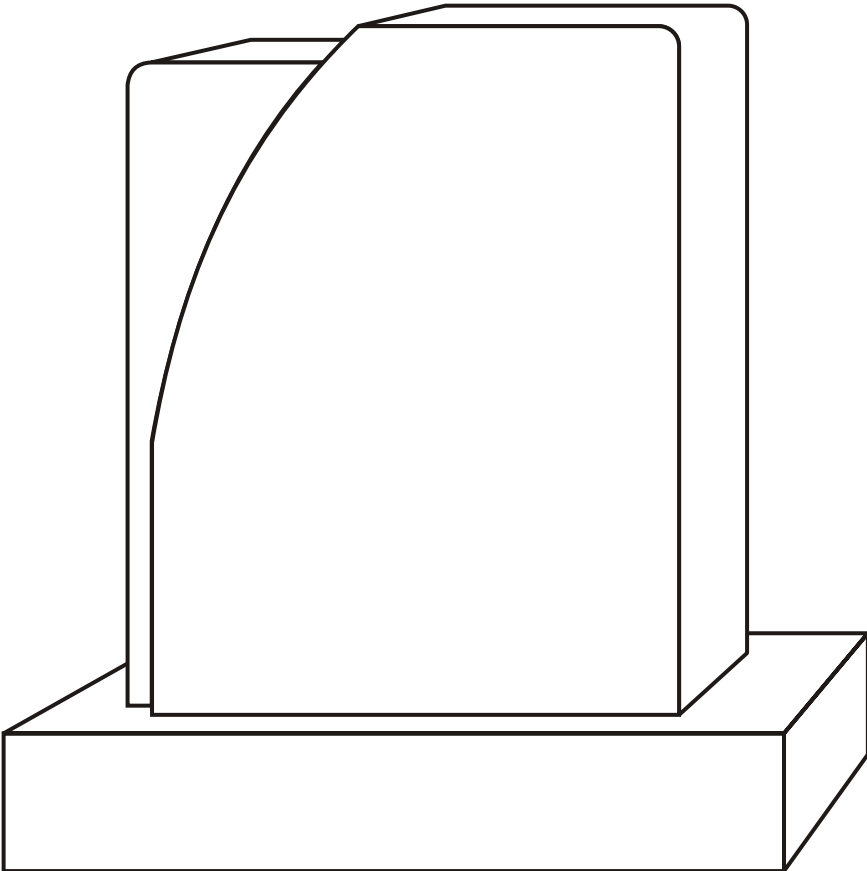

YOUR MAILING OR BUSINESS STAMP CAN GO HERE

AMC #: \_\_\_\_\_  
Send Layout to AMC#

Name: \_\_\_\_\_  
Contact Person

Material: \_\_\_\_\_  
Granite Color

**REQUEST OF A LAYOUT  
ORDER BUDDY WEBER STYLE**

Check Lettering Style(s)

Tablet Size: _____ X _____ X _____ Length Width Height	Model #: _____ Shape & Finish
Base Size: _____ X _____ X _____ Length Width Height	Model #: _____ Shape & Finish
Vase Size: _____ X _____ X _____ Quantity Length Width Height 1 2	Style: _____ Vase Type

- FLARE BLOCK
- FROSTED INLAID
- POLISHED EDGE**
- SAND SUNK**
- Script Lettering*
- SHADOW**
- VERMARCO**

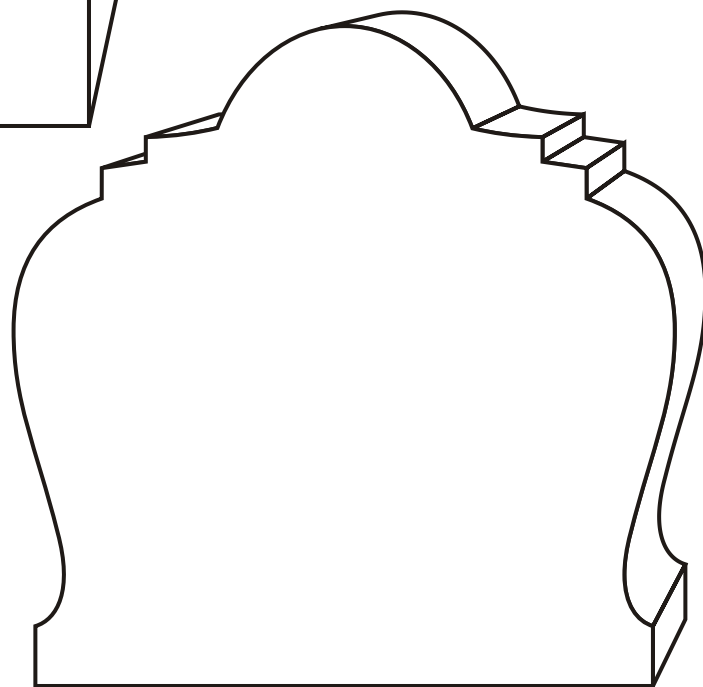
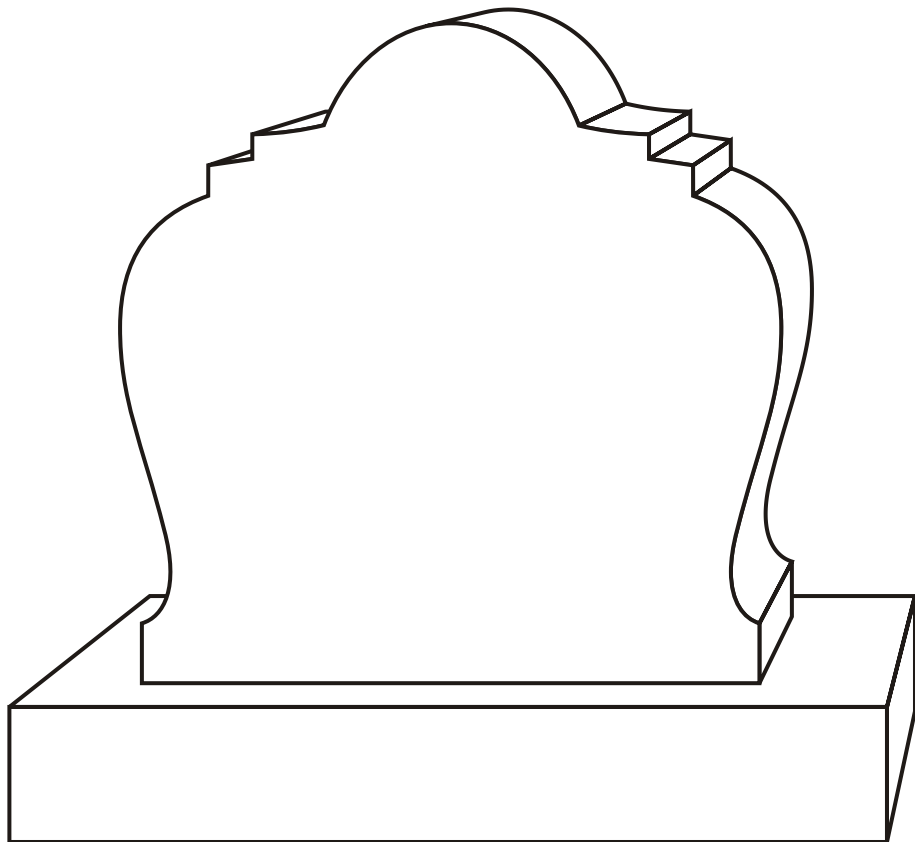

YOUR MAILING OR BUSINESS STAMP CAN GO HERE

AMC #: \_\_\_\_\_  
Send Layout to AMC#

Name: \_\_\_\_\_  
Contact Person

Material: \_\_\_\_\_  
Granite Color

**REQUEST OF A LAYOUT**  
**ORDER BUDDY EXCALIBUR STYLE**

Check Lettering Style(s)

Tablet Size: _____ X _____ X _____ Length Width Height	Model #: _____ Shape & Finish
Base Size: _____ X _____ X _____ Length Width Height	Model #: _____ Shape & Finish
Vase Size: _____ X _____ X _____ Quantity Length Width Height 1 2	Style: _____ Vase Type

- FLARE BLOCK
- FROSTED INLAID
- POLISHED EDGE**
- SAND SUNK**
- Script Lettering*
- SHADOW**
- VERMARCO**

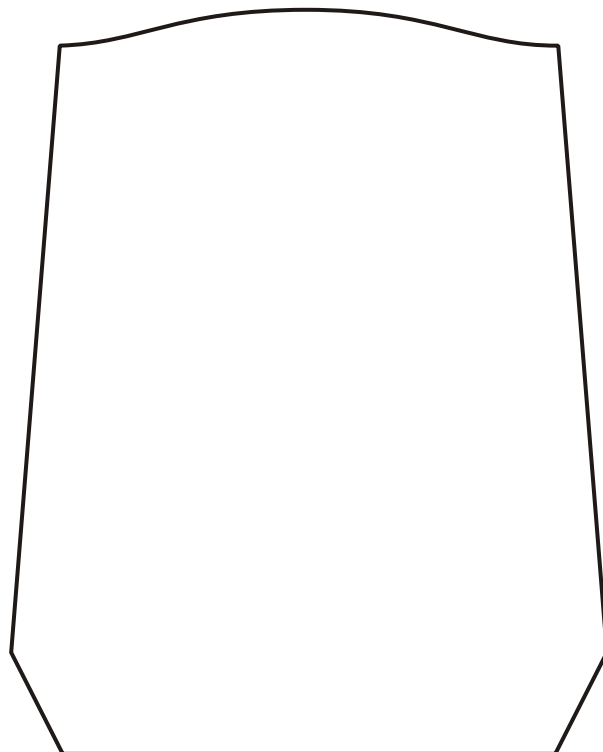
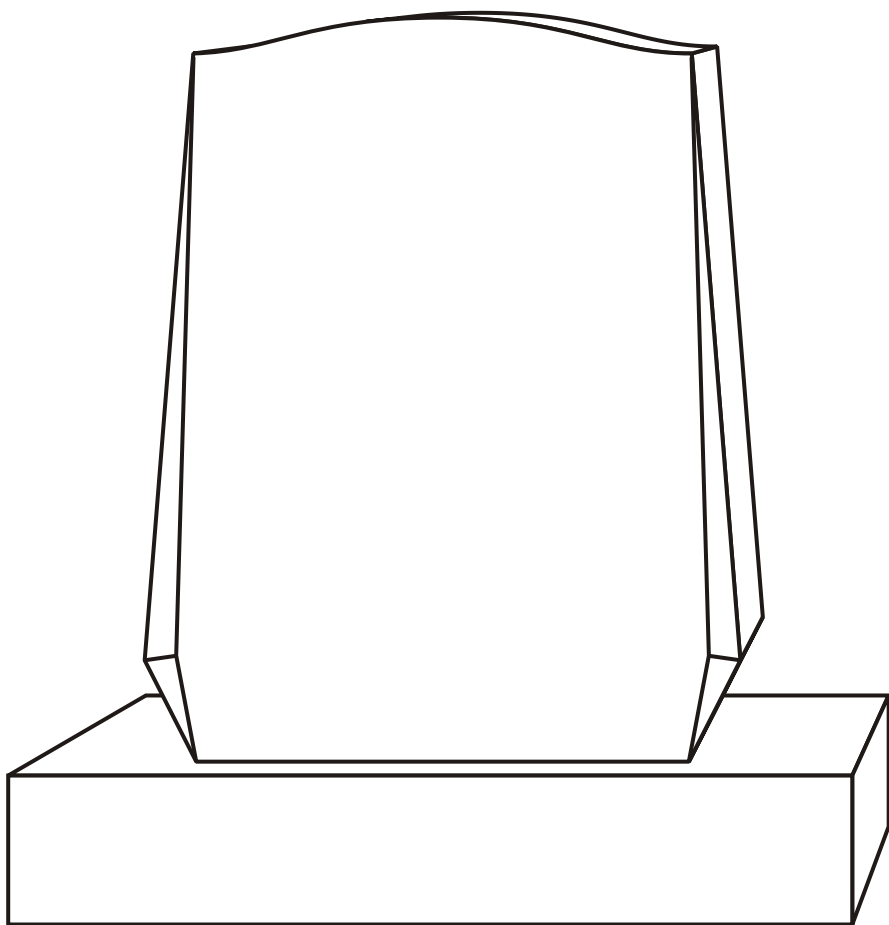

YOUR MAILING OR BUSINESS STAMP CAN GO HERE

AMC #: \_\_\_\_\_  
Send Layout to AMC#

Name: \_\_\_\_\_  
Contact Person

Material: \_\_\_\_\_  
Granite Color

**REQUEST OF A LAYOUT  
ORDER BUDDY STYLE 2016**

Check Lettering Style(s)

Tablet Size: _____ X _____ X _____ Length Width Height	Model #: _____ Shape & Finish
Base Size: _____ X _____ X _____ Length Width Height	Model #: _____ Shape & Finish
Vase Size: _____ X _____ X _____ Quantity Length Width Height 1 2	Style: _____ Vase Type

- FLARE BLOCK
- FROSTED INLAID
- POLISHED EDGE**
- SAND SUNK**
- Script Lettering*
- SHADOW**
- VERMARCO**

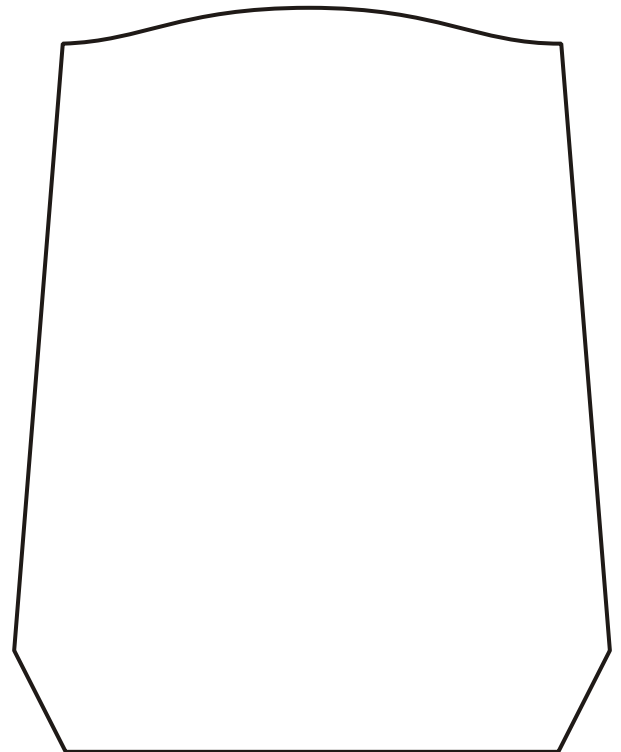
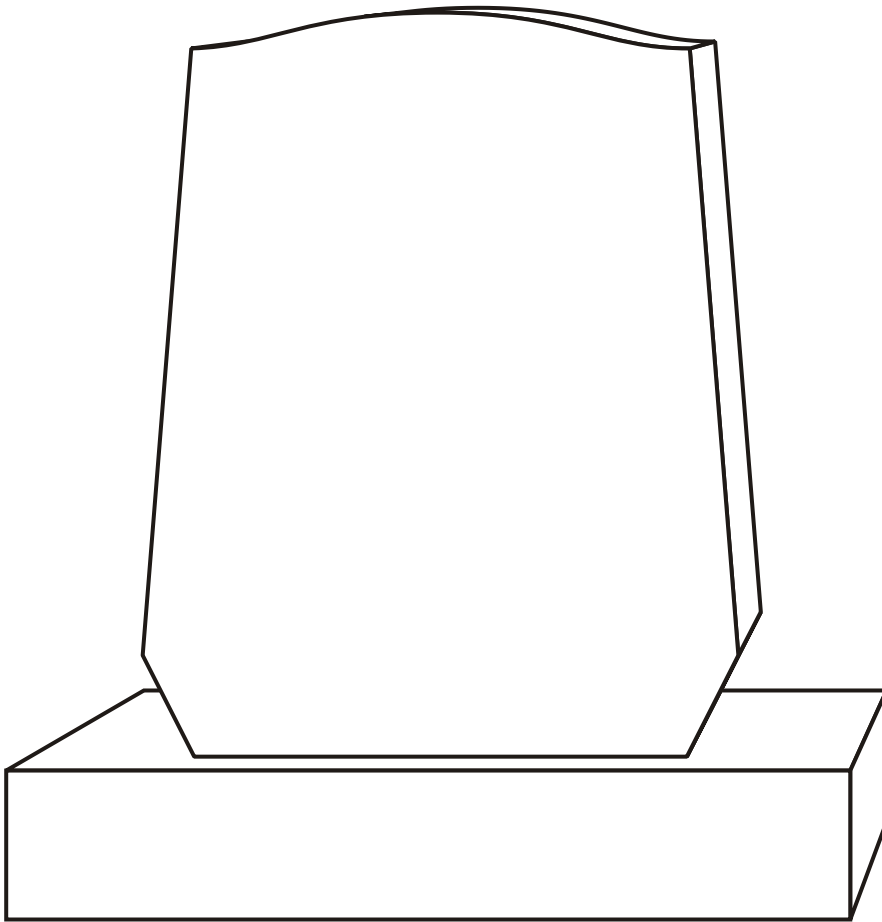

YOUR MAILING OR BUSINESS STAMP CAN GO HERE

AMC #: \_\_\_\_\_  
Send Layout to AMC#

Name: \_\_\_\_\_  
Contact Person

Material: \_\_\_\_\_  
Granite Color

**REQUEST OF A LAYOUT  
ORDER BUDDY STYLE L2015**

Check Lettering Style(s)

Tablet Size: _____ X _____ X _____ Length Width Height	Model #: _____ Shape & Finish
Base Size: _____ X _____ X _____ Length Width Height	Model #: _____ Shape & Finish
Vase Size: _____ X _____ X _____ Quantity Length Width Height 1 2	Style: _____ Vase Type

- FLARE BLOCK
- FROSTED INLAID
- POLISHED EDGE**
- SAND SUNK**
- Script Lettering*
- SHADOW**
- VERMARCO**

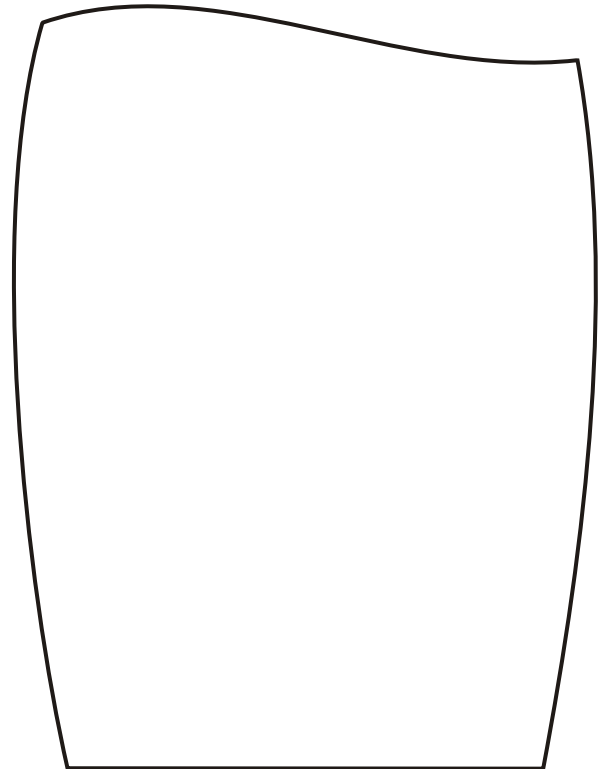
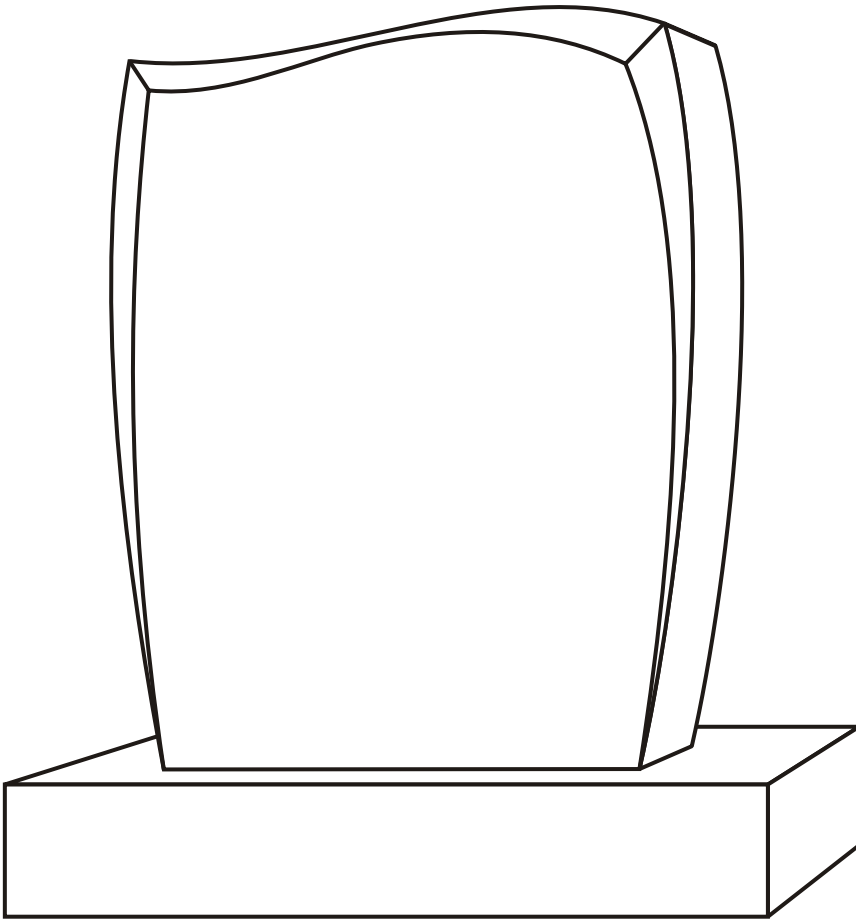

YOUR MAILING OR BUSINESS STAMP CAN GO HERE

AMC #: \_\_\_\_\_  
Send Layout to AMC#

Name: \_\_\_\_\_  
Contact Person

Material: \_\_\_\_\_  
Granite Color

**REQUEST OF A LAYOUT  
ORDER BUDDY BENCH RM774**

Check Lettering Style(s)

Seat Size: _____ X _____ X _____ Length Width Height	Model #: _____ Shape & Finish
Leg Size: _____ X _____ X _____ Length Width Height	Model #: _____ Shape & Finish
Base Size: _____ X _____ X _____ Length Width Height	Model #: _____ Shape & Finish

- FLARE BLOCK
- FROSTED INLAID
- POLISHED EDGE**
- SAND SUNK**
- Script Lettering*
- SHADOW**
- VERMARCO**

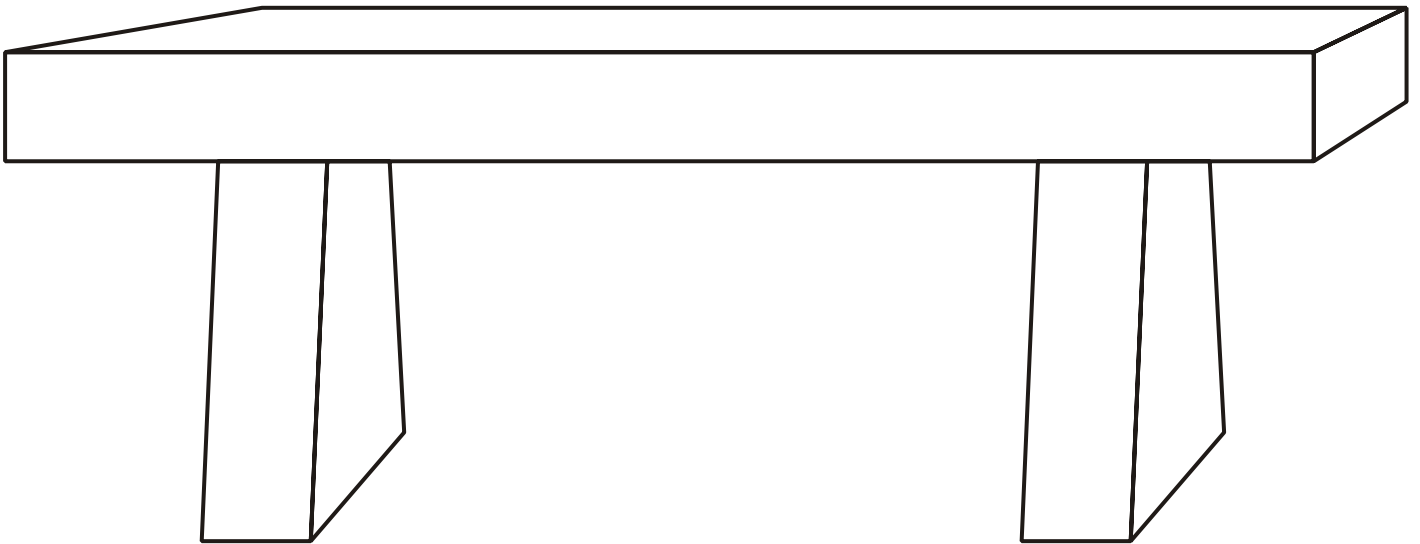
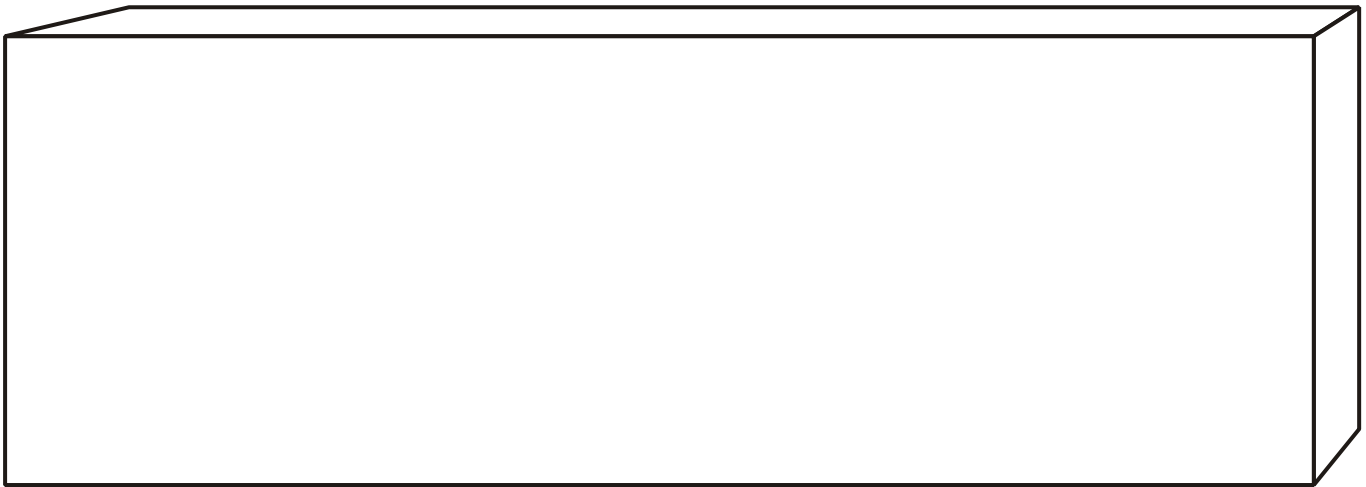

YOUR MAILING OR BUSINESS STAMP CAN GO HERE

AMC #: \_\_\_\_\_  
Send Layout to AMC#

Name: \_\_\_\_\_  
Contact Person

Material: \_\_\_\_\_  
Granite Color

**REQUEST OF A LAYOUT**  
**ORDER BUDDY BENCH RM775**

Check Lettering Style(s)

Seat Size: _____ X _____ X _____ Length Width Height	Model #: _____ Shape & Finish
Leg Size: _____ X _____ X _____ Length Width Height	Model #: _____ Shape & Finish
Base Size: _____ X _____ X _____ Length Width Height	Model #: _____ Shape & Finish

- FLARE BLOCK
- FROSTED INLAID
- POLISHED EDGE**
- SAND SUNK**
- Script Lettering*
- SHADOW**
- VERMARCO**

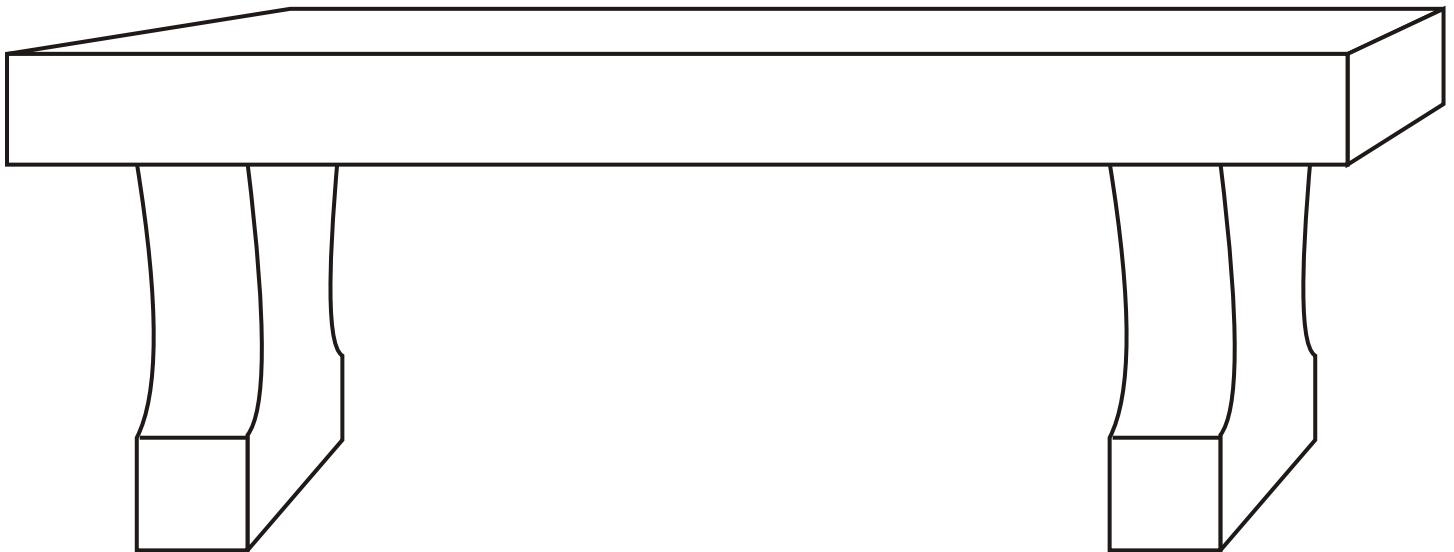
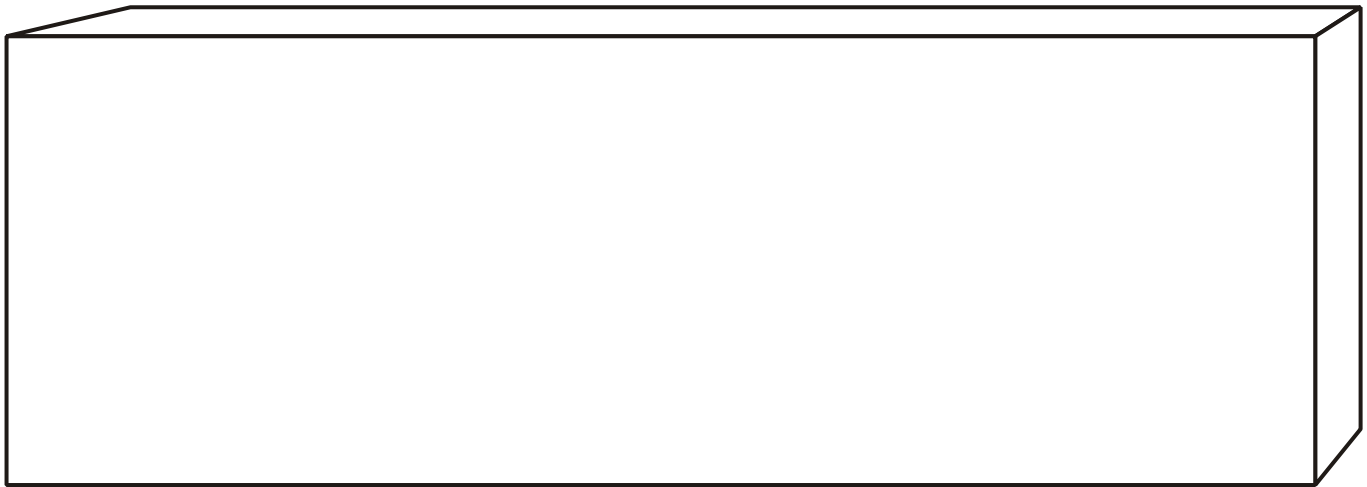

YOUR MAILING OR BUSINESS STAMP CAN GO HERE

AMC #: \_\_\_\_\_  
Send Layout to AMC#

Name: \_\_\_\_\_  
Contact Person

Material: \_\_\_\_\_  
Granite Color

**REQUEST OF A LAYOUT**  
**ORDER BUDDY BENCH RM788**

Check Lettering Style(s)

Seat Size: _____ X _____ X _____ Length Width Height	Model #: _____ Shape & Finish
Leg Size: _____ X _____ X _____ Length Width Height	Model #: _____ Shape & Finish
Base Size: _____ X _____ X _____ Length Width Height	Model #: _____ Shape & Finish

- FLARE BLOCK
- FROSTED INLAID
- POLISHED EDGE**
- SAND SUNK**
- Script Lettering*
- SHADOW**
- VERMARCO**

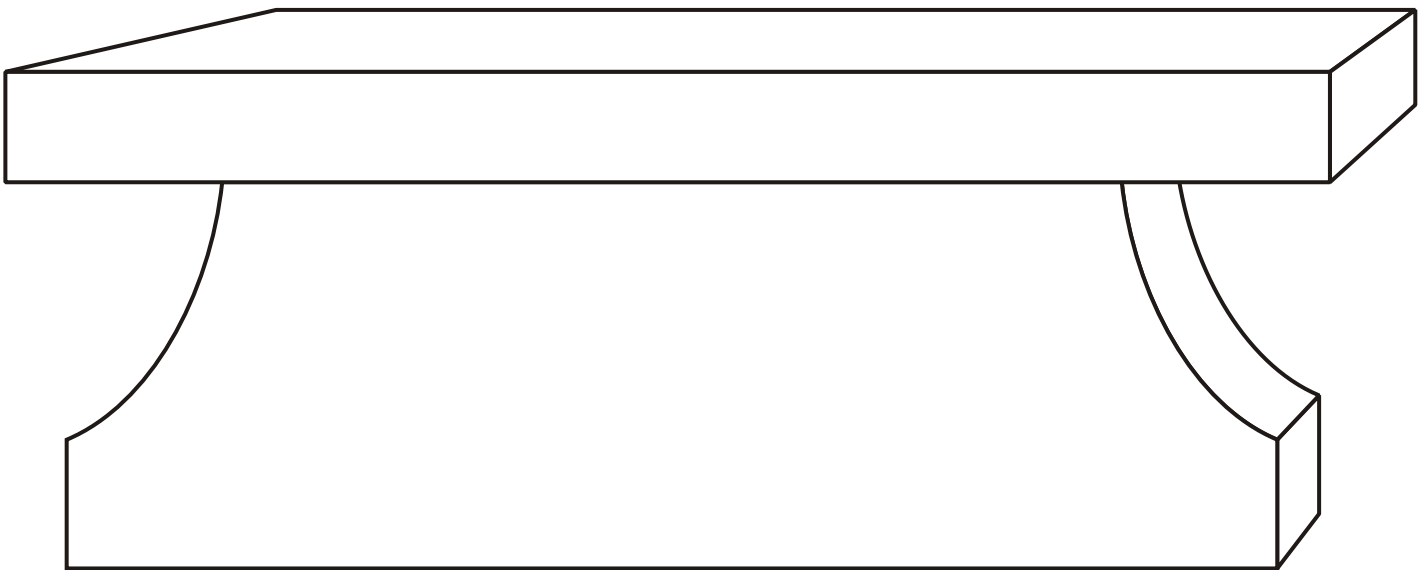
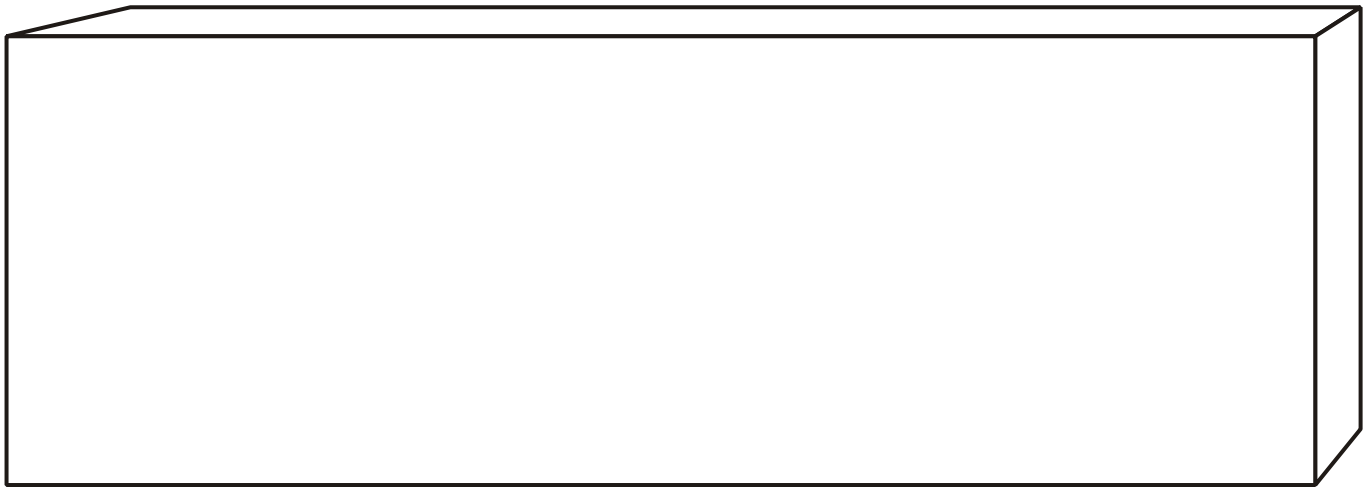

YOUR MAILING OR BUSINESS STAMP CAN GO HERE

AMC #: \_\_\_\_\_  
Send Layout to AMC#

Name: \_\_\_\_\_  
Contact Person